

**ABBATTITORI/SURGELATORI DI TEMPERATURA
CELLULES DE REFROIDISSEMENT RAPIDE/CELLULES MIXTES
SCHNELLKÜHLER/SCHOCKFROSTER
BLAST CHILLERS/FREEZERS
ABATIDORES/CONGELADORES RAPIDOS DE TEMPERATURA
AFKOEL/VRIESKAST
ABATEDORES/CONGELADORES RÁPIDOS DA TEMPERATURA
БЫСТРЫЕ ОХЛАДИТЕЛИ/МОРОЗИЛЬНИКИ**

**MANUALE D'USO E INSTALLAZIONE
MANUEL D'UTILISATION ET D'INSTALLATION
BEDIEN- UND INSTALLATIONSHANDBUCH
USE AND INSTALLATION MANUAL
MANUAL DE USO E INSTALACIÓN
HANDLEIDING
MANUAL DE USO
РУКОВОДСТВО К ИСПОЛЬЗОВАНИЮ**



IT

Leggere attentamente le avvertenze contenute nel presente libretto in quanto forniscono importanti indicazioni riguardanti la sicurezza, d'uso e di manutenzione.

Conservare con cura questo libretto per ogni ulteriore consultazione dei vari operatori.

Il costruttore si riserva il diritto di apportare modifiche al presente manuale, senza preavviso e responsabilità alcuna.

FR

Lire avec attention les instructions contenues dans ce livret car elles fournissent d'importants renseignements pour ce qui concerne la sécurité, l'emploi et l'entretien.

Garder avec soin ce livret pour des consultations ultérieures de différents opérateurs.

Le constructeur se réserve le droit d'apporter des modifications à ce manuel, sans préavis ni responsabilité d'aucune sorte.

DE

Lesen Sie bitte aufmerksam diese Gebrauchsanweisung durch, die wichtige Informationen bezüglich der Sicherheit, dem Gebrauch und der Instandhaltung enthält.

Heben Sie sorgfältig diese Gebrauchsanweisung auf, damit verschiedene Anwender sie zu Rat ziehen können.

Der Hersteller behält sich das Recht, Änderungen dieser Gebrauchsanweisung ohne Ankündigung und ohne Übernahme der Verantwortung vornehmen zu können.

GB

Carefully read the instructions contained in the handbook. You may find important safety instructions and recommendations for use and maintenance.

Please retain the handbook for future reference.

The Manufacturer is not liable for any changes to this handbook, which may be altered without prior notice.

ES

Lea atentamente las advertencias contenidas en este manual pues dan importantes indicaciones concernientes la seguridad, la utilización y el mantenimiento del aparato.

Rogamos guarde el folleto de instalación y utilización, para eventuales futuros usuarios.

El constructor se reserva el derecho de hacer modificaciones al actual manual, sin dar algún preaviso y sin responsabilidad alguna.

NL

Nauwkeurig de waarschuwingen in dit boekje lezen, aangezien zij belangrijke aanwijzingen verschaffen wat betreft de veiligheid, het gebruik en het onderhoud.

Dit boekje goed bewaren.

De fabrikant behoudt zich het recht voor om veranderingen in deze handleiding aan te brengen, zonder voorafgaande waarschuwing en zonder enkele aansprakelijkheid.

P

Leia com atenção as advertências contidas neste manual pois fornecem importantes indicações para a segurança, a utilização e a manutenção do aparelho.



O construtor reserva-se o direito de modificar o manual sem dar aviso prévio e sem nenhuma responsabilidade.

RU

Внимательно читайте предупреждения, содержащиеся в настоящем руководстве, касающиеся надежности использования и обслуживания.

Конструктор сохраняет за собой право вносить изменения в настоящее руководство без предупреждения и любой ответственности.

- INDEX -

1 st PART		INSTRUCTION MANUAL	3
2 st PART		INSTALLATION MANUAL	27

0	INFORMATION FOR THE READER	3
1	GENERAL INSTRUCTIONS ON DELIVERY	3
	• GENERAL INSTRUCTIONS	3
	• TECHNICAL DATA	3
	• LIST OF REGULATION REFERENCES	3
	• GENERAL INSTRUCTIONS	3
	• SETTING UP	4
	• TESTING	4
	MACHINE LOADING	5
	POSITION OF TRAYS	5
	LENGTH	5
	CORE PROBE	6
2	CONTROL PANEL	7
	• DESCRIPTION OF CONTROLS	7
3	OPERATION	10
	• PROGRAMS	10
	IFR SLAUGHTERING CYCLE	10
	RECOMMENDED	11
	USER'S CYCLE	11
	Use User's programmes	11
	Memorise User's programmes	12
	Cancel a User's programmes	13
	Rename a User's programmes	13
	PRE-COOLING CYCLE	14
	• MANUAL CYCLES	15
	Negative slaughter cycle with core probe	16
	Negative slaughter cycle with timer	16
	Soft positive slaughter cycle with core probe	17
	Soft positive slaughter cycle with time	18
	Hard positive slaughter cycle with core probe	18
	Hard positive slaughter cycle with time	19
	• STORE	20
	POSITIVE STORE	20
	NEGATIVE STORE	20
	• DEFROSTING	22
	• STERILIZATION	22
	• CLOCK SETTING	23
	• LANGUAGE	23
	• ALARM	23
	• SERVICE	23
	• INPUTS/OUTPUTS	23
4	MAINTENANCE	24
	• MAINTENANCE AND CLEANING	24
	CLEANING THE CABINET	24
	CLEANING THE AIR CONDENSER	25
	STAINLESS-STEEL MAINTENANCE	25
	DISCONTINUED USE	26



- INDEX -

• INSTALLATION	27
INTRODUCTION	27
MAX ROOM TEMPERATURE	27
POSITIONING	27
WIRING	29
PLEASE USE CERTIFIED APPROVED MATERIALS	29
CONNECTION TO CONDENSATE DRAIN	30
TESTING	30
• CLOCK SETTING	30
• LANGUAGE	30
• ALARMS AND FAULT ANALYSIS	31
• SERVICE	33
PARAMETERS	33
Description of parameters	33
Changing parameters	36
RESET MEMORY	36
RESTORE	37
• INPUTS/OUTPUTS	38
• STERILIZATION LAMP INSTALLATION	38
• PRINTER INSTALLATION	38
• MAINTENANCE OF PANEL BOARD	39
• WIRING DIAGRAM PLATE	40
• CONTROL AND SAFETY SYSTEMS	40
• DISPOSAL	40
• REFRIGERANT MATERIAL SAFETY DATA SHEET	41
• DIMENSIONS	42



ANNEXES	44
----------------------	-----------

- INSTRUCTION MANUAL -

INFORMATION FOR THE READER

CHAPTER 0

This manual is subdivided into two parts.



1st part: covers all the information necessary to the user.



2nd part: covers all the information necessary to the qualified operators authorized to move, transport, install, service, repair and demolish the appliance.

While users are instructed to refer to the 1st part only, the 2nd part is addressed to skilled operators. They may also read the 1st part for a more complete picture of the information provided if necessary.

GENERAL INSTRUCTIONS ON DELIVERY

CHAPTER 1

GENERAL INSTRUCTIONS

Make sure that the consignment has not been tampered with or damaged during transport.

After unpacking the cooling cabinet make sure all sections or components have been included and specifications and conditions are as to your order. If not, please inform the retailer immediately.

We assure you have made the best choice in purchasing our products and hope you will be fully satisfied with our their performance. To this purpose, we recommend you strictly comply with the instructions and regulations contained in this handbook.

Please remember that no reproductions of this handbook are allowed. Due to our constant technological updating and research, the features described in this handbook may be altered without prior notice.



TECHNICAL DATA

Please refer to the technical data of your own appliance. (tab.1a-1b)

LIST OF REGULATION REFERENCES

The cooling cabinet we manufacture fully complies with the following European and national regulations:

89/392;91/368;93/44 (machine regulations)
89/336 (EMC regulation)
73/23 (low-voltage regulation)
93/68 (new approach regulation)
658/88 CEE
108/89 CEE
DPR 327/80 art.31 (Italy)
D.M. 15-06-71 (Italy)
D.L. n°110 27-01-92 (Italy)

J.O. 16-07-74 n°74-163 (France) and the following
European regulations:
EN60204-1;EN292-I-II;EN294;EN349
EN55014;EN55104
EN60335-1;EN60335-2-24
EN378-1
NF D 40-001 (France)
NF E 35-400 (France)
U 60-010 (France)

GENERAL INSTRUCTIONS

The quick cooler is a refrigerating appliance which can cool cooked foodstuffs to a temperature of +3°C (positive quick cooling) and to -18°C (negative quick cooling).

Machine capacity as to the quantity to be cooled depend on the model purchased.

- INSTRUCTION MANUAL -

SETTING UP

Before setting to operation thoroughly clean the cooling cabinet with a suitable detergent or sodium bycarb dissolved in lukewarm water. Clean the appliance inside to remove any condensate caused by the Manufacturer's final testing.

Cooling and freezing speed depends on the following factors:

- a) container shape, type and material;
- b) whether container lids are used;
- c) foodstuff features (density, water contents, fat contents);
- d) starting temperature;
- e) thermal conduction inside the foodstuffs

Positive /Negative quick cooling time depends on type of foodstuffs to be processed.

Full-speed cycle is recommended for high-density or large-sized foodstuffs. However, the following limits should never be exceeded : 3,6 [kg] load (for GN1/1, EN1/1 or 60x40 sheets) or 7,2 [kg] load (for GN2/1, EN2/1 or 60x80 sheets), 50 [mm] thickness for negative quick cooling and 80 [mm] thickness for positive quick cooling (**tab.2**).

The low-speed cycle is suitable to process delicate foodstuffs, such as vegetables, creamy products, creamy desserts or low-thickness products.

We recommend making sure that any positive quick cooling cycles, up to +3 [°C] to the core of the product, do not last over 90 minutes, and that negative quick cooling cycles, up to -18 [°C] to the core of the product, do not last over 4 hours.

The processing room is to be pre-cooled before starting the positive and /or negative quick cooling cycle. Moreover, avoid covering the foodstuffs during the cycle, which would increase the cycle length.

We recommend using the core probe in order to have the exact core temperature reading. Do not stop the cycle before reaching a temperature of +3 [°C] during positive quick cooling and -18[°C] during negative quick cooling.



Tab.2

Model	Max. output/cycle		Capacity		
	+70[°C]÷+3[°C]	+70[°C]÷-18[°C]	n° max	GN	EN
DS31-DS31A-DS31M-DS31C	10,8[kg]	3,6[kg]	3	1/1	600X400
IS51-IS51A-IS51M-IS51C	20[kg]	12[kg]	5	1/1	600X400
DS51-DS51A-DS51M-DS51C					
IA51-IA51A-IA51M-IA51C	18[kg]	-	5	1/1	600X400
IS51H	16[kg]	10[kg]	5	1/1	600X400
FS611	30[kg]	18[kg]	6	1/1	600X400
IS101L-IS101S	42[kg]	25[kg]	10	1/1	600X400
IA101L-IA101S	36[kg]	-	10	1/1	600X400
IS72S	52[kg]	25[kg]	10	2/1	
IA72S	51[kg]	-	10	2/1	
IS102S-IS102SR	100[kg]	50[kg]	10	2/1	
ISR201R	120[kg]	72[kg]	20	1/1	600X400
ISR202R-ISP202R	210[kg]	144[kg]	20	2/1	600X800

TESTING

Name and Surname	Address	Tel./fax no.

- INSTRUCTION MANUAL -

MACHINE LOADING

Do not pile up foodstuffs to be cooled. Thickness should be lower than 50 mm] in negative quick cooling and lower than 80[mm] in positive quick cooling. **(pict.1)**

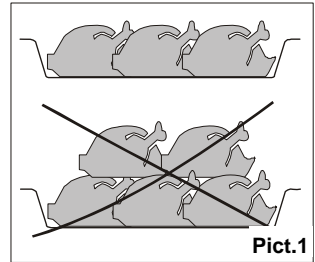

Pict.1

Make sure air circulation is not hampered between food trays. **(pict.2)**

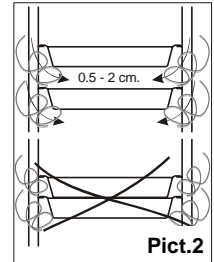

Pict.2

The grid-holding frame (included in those models which include trolleys) is to be located at the centre of the cabinet. **(pict.3)**

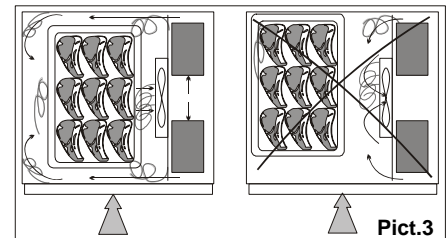

Pict.3

POSITION OF TRAYS

Place the trays as close to the evaporator as possible. **(pict.4)**

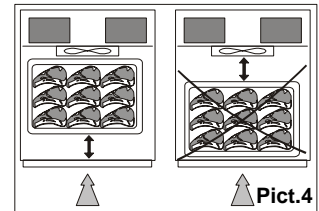

Pict.4

If the cabinet is not full place the trays at equal distance from one another. **(pict.5)**

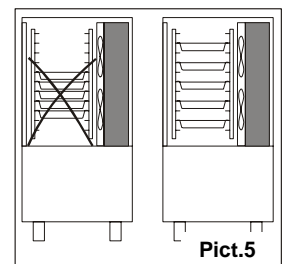

Pict.5

LENGTH

Cooled or frozen processed foodstuffs may be stored in a refrigerator for 5 days of processing with no quality alterations.

For best results we recommend keeping temperature constant throughout the storing (0°C to 4°C), according to the various commodities.

Storing time may be increased to approx. two weeks by using vacuum processing.

After a negative quick cooling cycle, foodstuffs may be stored safely for 3 to 18 months, according to the type of foodstuff processed.

We strongly recommend keeping storing temperature at -20°C or below.

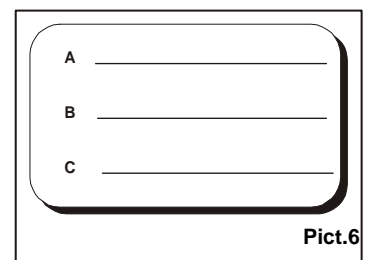

Pict.6

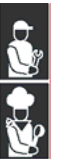

- INSTRUCTION MANUAL -

Table 3 shows the storing time rates for a few examples of frozen food. Do not leave cooked products at room temperature before quick cooling. Avoid any loss of moisture, which will affect food freshness. The cooled product should be wrapped in a specific film for foodstuffs (better still, vacuum stored) and provided with a sticker reporting the content [A], date of processing [B] and expiry date [C] written in permanent type ink (**pict.6**).

Tab.3

Foodstuff	Storing temperature [°C]	Recommended storing time
Pork	-18	6
Beef	-18	9
Poultry	-18	10
Fat fish	-18	2
Lean fish	-18	4
Peas	-18	12
Strawberries	-18	12
Spinach	-18	6

CORE PROBE

For proper position of the probe, refer to the following pictures.

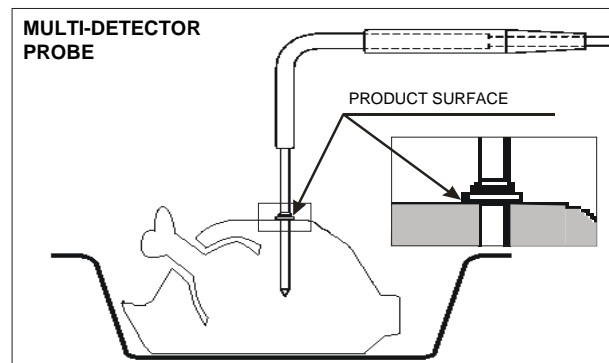
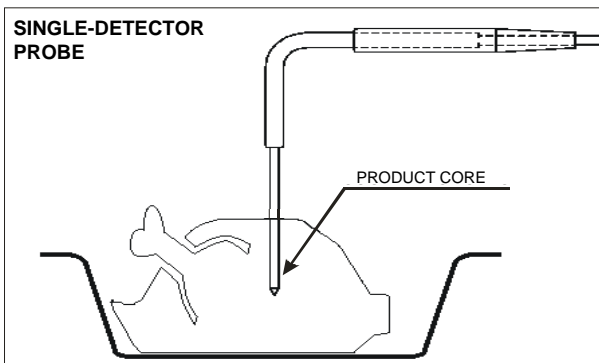

- INSTRUCTION MANUAL -

CONTROL PANEL

CHAPTER 2

DESCRIPTION OF CONTROLS

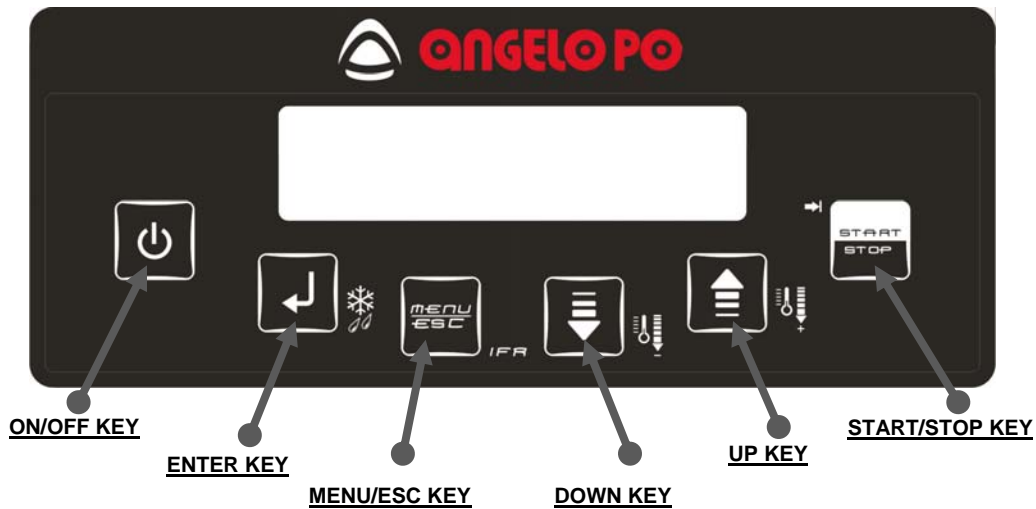

	<p><u>ON/OFF key</u> Pressing the key for 5 sec the controller turns off and the sign blinks on the display </p> <p>When the button is repeatedly pressed the controller lights up again, preparing itself to start an IFR slaughter cycle. </p>
	<p><u>Enter key</u> Allows access to a menu or parameter selection.</p> <p>Manual defrost: press the key for 5 s (default parameter values)</p> <p>During a cycle: press the button to display all the information regarding the ongoing cycle. Press to scroll through this information.</p>
	<p><u>Menu/Esc key</u> Allows access to the main menu or return to the previous menu.</p> <p>Quick IFR slaughter key: press the key for 5 s (default parameter values)</p>
	<p><u>Up e Down keys</u> Allow to scroll the different menus or change parameter values.</p> <p>Quick Soft posit. slaughter key: press the key for 5 s (default parameter values)</p> <p>Quick negative slaughter key: press the key for 5 s (default parameter values)</p> <p>Keyboard lock: press the keys for 5s (default parameter values)</p> <p>During a cycle: press the button to display, for a few seconds, the elapsed time.</p>
	<p><u>Start/Stop key</u> Allow to start/stop a quick cooling cycle.</p> <p>Quick cooling key: keep the key pressed for 5 s (default parameters)</p>



- INSTRUCTION MANUAL -

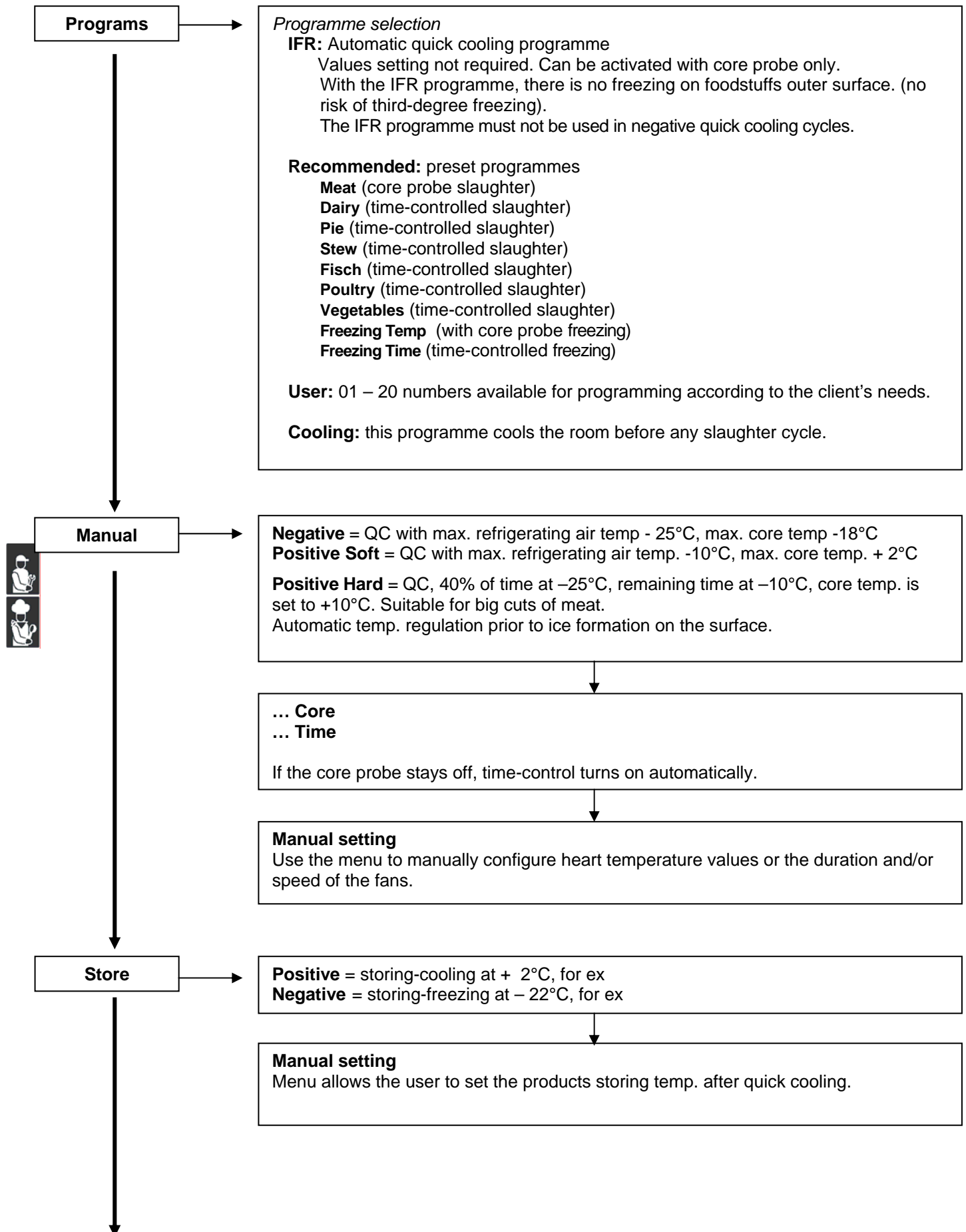

- INSTRUCTION MANUAL -

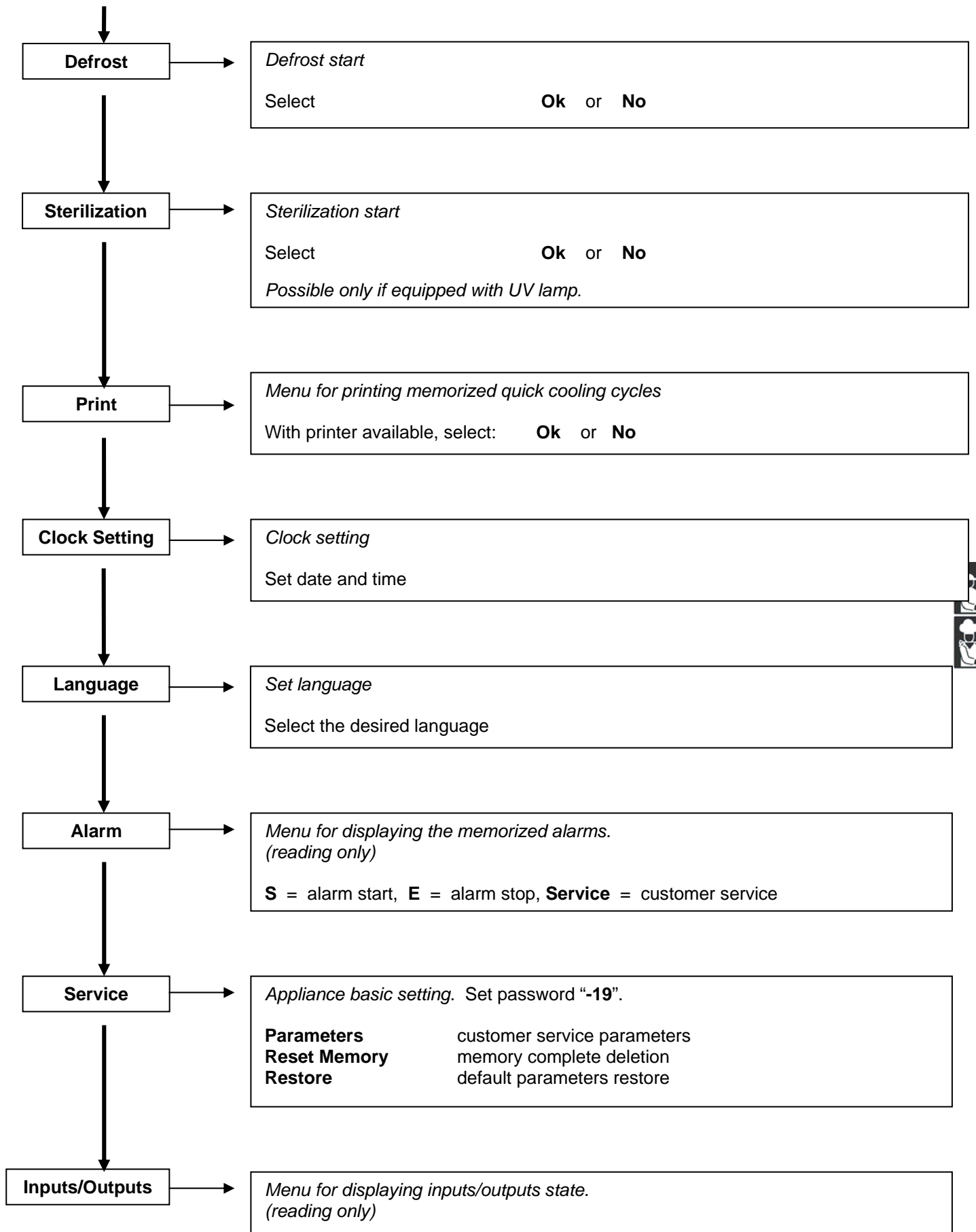

- INSTRUCTION MANUAL -

OPERATION

CHAPTER 3

PROGRAMS

IFR SLAUGHTERING CYCLE

I.F.R.

(Intelligent Food Recognition)



The IFR is an innovative patented system of positive quick cooling which allows the cycle optimisation for each type of foodstuffs **by preventing superficial freezing.**



Temperatures are detected by a three-sensor multipoint needle probe. The position inside the foodstuff is determined univocally by a reference disk located along the needle. (ref. pag 6, par. "Core probe").



	Press menu/esc to select the desired menu
	Use the keys up and down to display
	Press enter to confirm your choice. The display shows
	Press start/stop to immediately activate the selected cycle

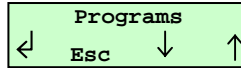

Notes:



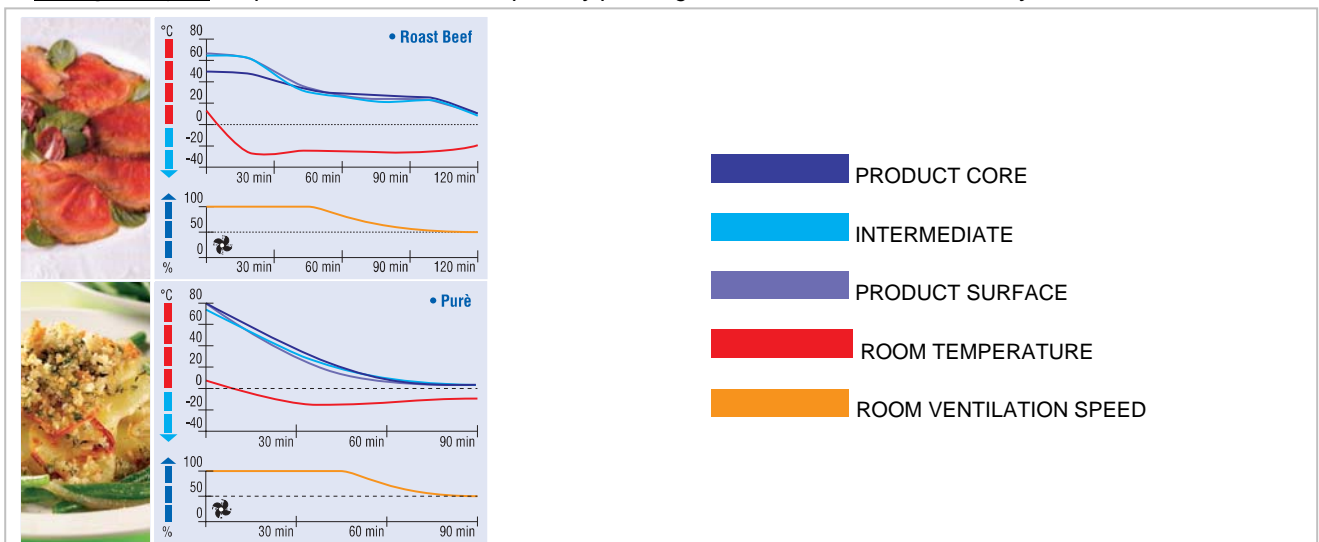







- **during switch on**, the controller automatically prepares itself to start an IFR slaughter cycle: simply press and the cycle will start immediately.
- **from the main menu** it is possible to immediately start an IFR slaughter cycle: keep the pressed for 5 seconds.
- **during the cycle** it is possible to visualise fan speed by pressing ; use the button to modify the value.

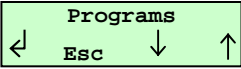

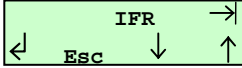
- INSTRUCTION MANUAL -

RECOMMENDED

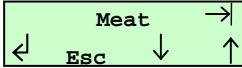
PRESET programmes are working cycles recommended by the manufacturer. Parameters cannot be changed.

	Press menu/esc to select the desired menu
	Use the keys up and down to display 
	Press enter to confirm your choice. The display shows 
	Use the keys up and down to display 
	Press enter to gain access to the memorized programmes selection (21-29) The display shows the programme number and name 
	Use the keys up and down to scroll all the memorized programmes
	Press start/stop to immediately activate the selected cycle

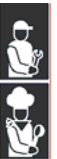



The recommend programmes are listed below:

Prog	Name of the programme	Positive negative	Time/Core	hard	Room set storing	time	Ventilat.
21	Meat	positive	core	yes	+2°C	120 min	100%
22	Dairy	positive	time	no	+2°C	90 min	100%
23	Pie	positive	time	no	+2°C	90 min	100%
24	Stew	positive	time	no	+2°C	90 min	100%
25	Fisch	positive	time	yes	+2°C	90 min	100%
26	Poultry	positive	time	yes	+2°C	90 min	100%
27	Vegetables	positive	time	no	+2°C	90 min	100%
28	Freezing Temp	negative	core	yes	-22°C	240 min	100%
29	Freezing Time	negative	time	yes	-22°C	240 min	100%

USER'S CYCLE

USE USER'S PROGRAMMES

The memorized USER programmes can be activated as follows:

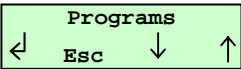
	Press menu/esc to select the desired menu
	Use the keys up and down to display 

- INSTRUCTION MANUAL -

	Press enter to confirm your choice. The display shows
	Use the keys up and down to display
	Press enter to confirm your choice. The display shows <i>(example)</i>
	Use the keys up and down to scroll all the memorized programmes
	Press start/stop to immediately activate the selected cycle

MEMORISE USER'S PROGRAMMES











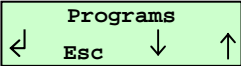

It is possible to memorize up to 20 USER programmes.

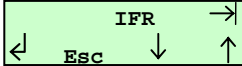

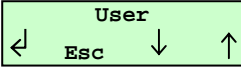

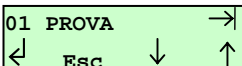

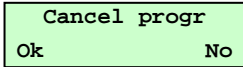

	Press menu/esc to select the desired menu
	Use the keys up and down to display
	Press enter to confirm your choice. Select the manual cycle as described in the previous paragraphs, replacing the standard values with the desired ones. Once the cycle is completely configured, the display will show. <i>(example)</i>
	Keep menu/esc pressed for 5 seconds to memorise the programme. The display will show the first available position
	Use buttons to scroll through the 20 programmes and select the desired position.
	Press enter to confirm the selected position. The display shows <i>Type in the name of the programme which is to be memorised using buttons to scroll through the letters and numbers, and press to confirm and move on to the next character</i>
	Press menu/esc to save the name. The display shows <i>(example)</i>
	Press start/stop to immediately activate the selected cycle

- INSTRUCTION MANUAL -

CANCEL A USER'S PROGRAMMES

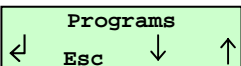
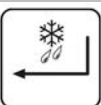
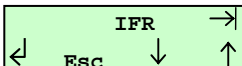

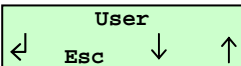
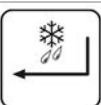
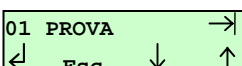





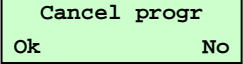

	Press menu/esc to select the desired menu
	Use the keys up and down to display 
	Press enter to confirm your choice. The display shows 
	Use the keys up and down to display 
	Press enter to confirm your choice. The display shows 
	Use the keys up and down to scroll all the memorized programmes
	Keep menu/esc pressed for 5 seconds. The display shows 
	Press enter to cancel the programme
	Press menu/esc several times to exit

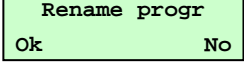
RENAME A USER'S PROGRAMMES

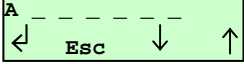
	Press menu/esc to select the desired menu
	Use the keys up and down to display 
	Press enter to confirm your choice. The display shows 
	Use the keys up and down to display 
	Press enter to confirm your choice. The display shows 
	Use the keys up and down to scroll all the memorized programmes









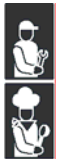

- INSTRUCTION MANUAL -

	Keep menu/esc pressed for 5 seconds. The display shows 
	Press up. The display shows 
	Press enter. The display shows  Type in the name of the programme which is to be memorised using buttons   to scroll through the letters and numbers, and press  to confirm and move on to the next character.
	Press menu/esc to confirm the new name
	Press menu/esc several times to exit

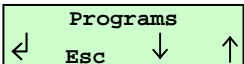
PRE-COOLING CYCLE

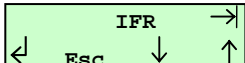
It is advisable to run a cooling cycle prior to selecting any slaughter cycle.

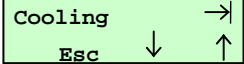

	Press menu/esc to select the desired menu
	Use the keys up and down to display 
	Press enter to confirm your choice. The display shows 
	Use the keys up and down to display 
	Press the start/stop button to immediately activate the cooling cycle

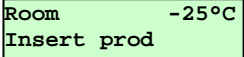
Once the temperature in the room reaches -25°C , the buzzer will sound for 10 seconds, and the “insert product” request will be displayed. 

Closing the door terminates the cooling cycle.

Note: From the main menu it is possible to immediately activate a cooling cycle; simply keep the  button pressed for 5 seconds.

- INSTRUCTION MANUAL -

MANUAL CYCLES

▪ NEGATIVE SLAUGHTER CYCLE

WITH CORE PROBE: cycle suitable for freezing foodstuffs using a room temperature of about -25[°C]. The cycle is controlled by the core probe.

WITH TIMER: cycle suitable for freezing foodstuffs using a room temperature of about -25[°C]. The cycle is time-controlled.

▪ SOFT POSITIVE SLAUGHTER CYCLE

WITH CORE PROBE: cycle suitable for cooling foodstuffs with thickness lower than 4[cm] using a room temperature of about 0[°C]. The cycle is controlled by the core probe.

WITH TIMER: cycle suitable for cooling foodstuffs with thickness lower than 4[cm] using a room temperature of about 0[°C]. The cycle is time-controlled.

▪ HARD POSITIVE SLAUGHTER CYCLE

WITH CORE PROBE: cycle suitable for cooling foodstuffs with thickness exceeding 4[cm] using a room temperature ranging from -25[°C] to -5[°C]. The cycle is controlled by the core probe.

WITH TIMER: cycle suitable for cooling foodstuffs with thickness exceeding 4[cm] using a room temperature ranging from -25[°C] to -5[°C]. The cycle is time-controlled.

NOTE: At the end of the slaughter or freezing cycle the system will automatically switch to the conservation mode (+2° C at the end of the positive slaughter and -22° C at the end of the freezing phase).













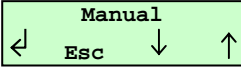
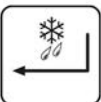

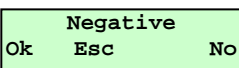
Cooling time

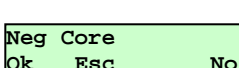
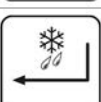
FOODSTUFF	SHEET	MAX. LOAD	PRODUCT THICKNESS	QUICK COOLING TIME	CYCLE
FIRST COURSES					
Bechamel	GN1/1 h60	6 lt	4 cm	70 minutes	HARD POSITIVE
Meat broth	GN1/1 h110	8 lt	6-7 cm	110 minutes	HARD POSITIVE
Cannelloni	GN1/1 h40	4 Kg	3-4 cm	40 minutes	HARD POSITIVE
Vegetable soup	GN1/1 h100	5 lt	5 cm	100 minutes	HARD POSITIVE
Fresh pasta	GN1/1 h40	1 Kg	5 cm	20 minutes	NEGATIVE
Meat and tomato sauce	GN1/1 h60	5 Kg	5 cm	90 minutes	HARD POSITIVE
Bean soup	GN1/1 h60	5 Kg	5 cm	100 minutes	HARD POSITIVE
Fish soup	GN1/1 h60	4 Kg	5 cm	110 minutes	HARD POSITIVE
MEAT AND POULTRY					
Roast pork	GN1/1 h60	8 Kg	10 cm	110 minutes	HARD POSITIVE
Braised beef	GN1/1 h60	8 Kg	15 cm	110 minutes	HARD POSITIVE
Boiler beef	GN1/1 h60	6 Kg	12-18 cm	110 minutes	HARD POSITIVE
Chicken breast	GN1/1 h40	5 Kg	4-5 cm	30 minutes	SOFT POSITIVE
Roast-beef	GN1/1 h40	4 Kg	10-15 cm	80 minutes	HARD POSITIVE
FISH					
Baked grouper	GN1/1 h40	3 Kg	5-10 cm	110 minutes	HARD POSITIVE
Squill	GN1/1 h40	2 Kg	3 cm	25 minutes	HARD POSITIVE
Vacuum-stored mussel	GN1/1 h60	2 Kg	max 3-4 cm	20 minutes	HARD POSITIVE
Fish salad	GN1/1 h40	4 Kg	3-4 cm	30 minutes	NEGATIVE
Boiled polyp	GN1/1 h60	5 Kg	-	60 minutes	HARD POSITIVE
Stewed cuttlefish	GN1/1 h60	4 Kg	4-5 cm	60 minutes	HARD POSITIVE
VEGETABLES					
Carrots trifolate	GN1/1 h60	4 Kg	4-5 cm	60 minutes	HARD POSITIVE
Mushrooms trifolati	GN1/1 h60	4 Kg	4-5 cm	60 minutes	HARD POSITIVE
Zucchini trifolate	GN1/1 h60	3 Kg	4-5 cm	90 minutes	HARD POSITIVE
PASTRY/DESSERT					
Vanilla / chocolate pudding	GN1/1 h60	6 lt	4-5 cm	90 minutes	SOFT POSITIVE
Creme anglaise	GN1/1 h60	3 lt	4-5 cm	100 minutes	SOFT POSITIVE
Custard a	GN1/1 h60	3 lt	4-5 cm	100 minutes	SOFT POSITIVE
Panna cotta (single portion)	GN1/1 h40	3 lt	6 cm	60 minutes	SOFT POSITIVE
Ice-cream cake	GN1/1 h40	3 Kg	4-6 cm	50 minutes	SOFT POSITIVE
Tiramisù	GN1/1 h60	5 Kg	4-5 cm	45 minutes	SOFT POSITIVE

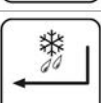
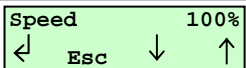

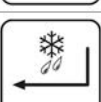
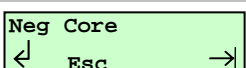

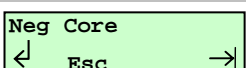



- INSTRUCTION MANUAL -

NEGATIVE SLAUGHTER CYCLE WITH CORE PROBE



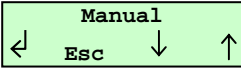
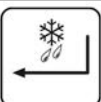

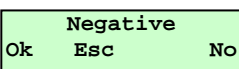

	Press menu/esc to select the desired menu
	Use the keys up and down to display 
	Press enter to confirm your choice.
	Press up to display 
	Press enter to confirm your choice.
	Press up to display 
	Press enter to confirm your choice. The display shows  Use buttons   to modify the set point value of the temperature in the room.
	Press enter to confirm your choice. The display shows  Use buttons   to modify fan speed
	Press enter to confirm your choice. The display shows 
	Press start/stop to immediately activate the selected cycle





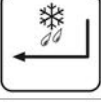
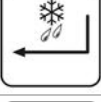
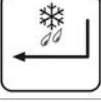

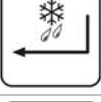



NEGATIVE SLAUGHTER CYCLE WITH TIME

	Press menu/esc to select the desired menu
	Use the keys up and down to display 
	Press enter to confirm your choice.
	Press up to display 
	Press enter to confirm your choice.

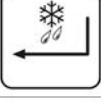
- INSTRUCTION MANUAL -

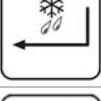
	Press up to display Neg Time Ok Esc No
	Press enter to confirm your choice. The display shows Neg Time 90' ← Esc ↓ ↑ <i>Use buttons   to modify the duration of the cycle.</i>
	Press enter to confirm your choice. The display shows Speed 100% ← Esc ↓ ↑ <i>Use buttons   to modify fan speed</i>
	Press enter to confirm your choice. The display shows Neg Time ← Esc →
	Press start/stop to immediately activate the selected cycle

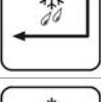
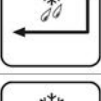
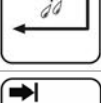
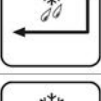

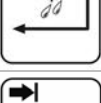
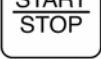

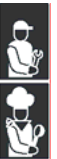



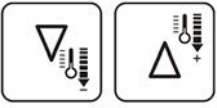
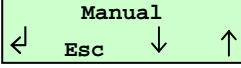

SOFT POSITIVE SLAUGHTER CYCLE WITH CORE PROBE

	Press menu/esc to select the desired menu
 	Use the keys up and down to display Manual ← Esc ↓ ↑
	Press enter to confirm your choice.
	Press up to display Positive Soft Ok Esc No
	Press enter to confirm your choice.
	Press up to display Soft Core Ok Esc No
	Press enter to confirm your choice. The display shows Soft Core -25°C ← Esc ↓ ↑ <i>Use buttons   to modify the set point value of the temperature in the room.</i>
	Press enter to confirm your choice. The display shows Speed 100% ← Esc ↓ ↑ <i>Use buttons   to modify fan speed</i>
	Press enter to confirm your choice. The display shows Soft Core ← Esc →
	Press start/stop to immediately activate the selected cycle

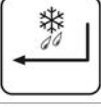

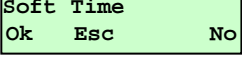
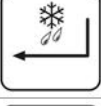
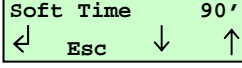
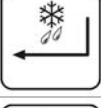

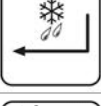

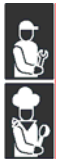

- INSTRUCTION MANUAL -

SOFT POSITIVE SLAUGHTER CYCLE WITH TIME



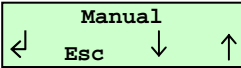

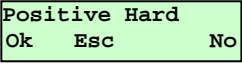



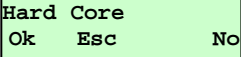

	Press menu/esc to select the desired menu
	Use the keys up and down to display 
	Press enter to confirm your choice.
	Press up to display 
	Press enter to confirm your choice.
	Press up to display 
	Press enter to confirm your choice. The display shows 
	Press enter to confirm your choice. The display shows 
	Press enter to confirm your choice. The display shows 
	Press start/stop to immediately activate the selected cycle



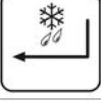



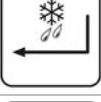
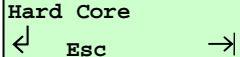







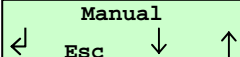
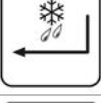

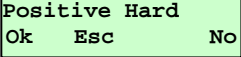
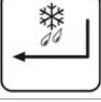

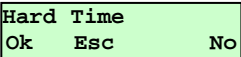
HARD POSITIVE SLAUGHTER CYCLE WITH CORE PROBE

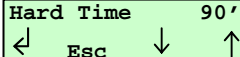
	Press menu/esc to select the desired menu
	Use the keys up and down to display 
	Press enter to confirm your choice.
	Press up to display 
	Press enter to confirm your choice.

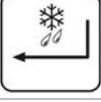
- INSTRUCTION MANUAL -

	Press up to display 
	Press enter to confirm your choice. The display shows  Use buttons   to modify the set point value of the temperature in the room.
	Press enter to confirm your choice. The display shows  Use buttons   to modify fan speed
	Press enter to confirm your choice. The display shows 
	Press start/stop to immediately activate the selected cycle

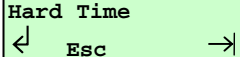
HARD POSITIVE SLAUGHTER CYCLE WITH TIME

	Press menu/esc to select the desired menu
 	Use the keys up and down to display 
	Press enter to confirm your choice.
	Press up to display 
	Press enter to confirm your choice.
	Press up to display 
	Press enter to confirm your choice. The display shows  Use buttons   to modify the duration of the cycle.
	Press enter to confirm your choice. The display shows  Use buttons   to modify fan speed
	Press enter to confirm your choice. The display shows 
	Press start/stop to immediately activate the selected cycle













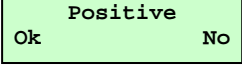

- INSTRUCTION MANUAL -

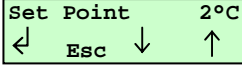
STORE

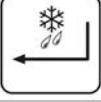
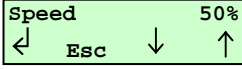

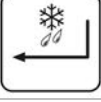





Storing cycles and quick cooling cycles can be started separately

POSITIVE STORE

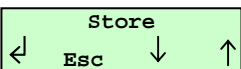

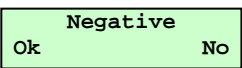

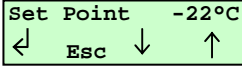

	Press menu/esc to select the desired menu
	Use the keys up and down to display 
	Press enter to confirm your choice.
	Press up to display 
	Press enter to confirm your choice. The display shows  Use buttons  to modify the set point value of the temperature in the room.
	Press enter to confirm your choice. The display shows  Use buttons  to modify fan speed.
	Press enter to confirm your choice. The display shows 
	Press the key start/stop to start the storing cycle immediately

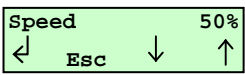

NEGATIVE STORE

	Press menu/esc to select the desired menu
	Use the keys up and down to display 
	Press enter to confirm your choice.
	Press up to display 
	Press enter to confirm your choice. The display shows  Use buttons  to modify the set point value of the temperature in the room.

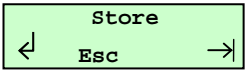



- INSTRUCTION MANUAL -

	<p>Press enter to confirm your choice. The display shows Use buttons   to modify fan speed.</p>	
	<p>Press enter to confirm your choice. The display shows</p>	
	<p>Press the key start/stop to start the storing cycle immediately</p>	

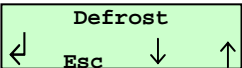
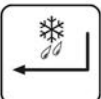
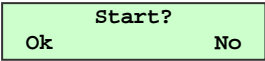

- INSTRUCTION MANUAL -

DEFROSTING

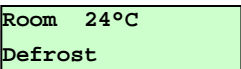
	Press menu/esc to select the desired menu
	Use the keys up and down to display 
	Press enter to gain access to the defrost activation The display shows 
	Press enter to immediately activate the defrosting cycle. The display shows 







Press  to deactivate the defrosting cycle

Note: immediate defrost can be started from the main menu by pressing the key  for at least 5 seconds

STERILIZATION

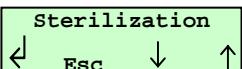

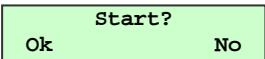
NOTE: the germicidal lamp kit is not supplied as standard equipment. It is an optional item.

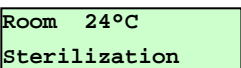
	Press menu/esc to select the desired menu
	Use the keys up and down to display 
	Press enter to gain access to the defrost activation The display shows 
	Press enter to gain access to the mode for starting sterilisation The display shows 

Opening the door interrupts the sterilisation process; press  to deactivate the sterilisation.

- INSTRUCTION MANUAL -

PRINT



NOTE: the printer is not supplied as standard equipment. It is an optional item.

	Press menu/esc to select the desired menu
	Use the keys up and down to display <div style="border: 1px solid black; padding: 2px; display: inline-block; margin-left: 20px;"> Print ← Esc ↓ ↑ </div>
	Press enter to gain access to the mode for printing the quick cooling cycles memorized The display shows <div style="border: 1px solid black; padding: 2px; display: inline-block; margin-left: 20px;"> Print Data? Ok No </div>
	Press Enter to start printing the memorized cycles (quick cooler name, date, number of programme being used, name of programme being used, temperature setpoint and quick cooling type, starting time and room/core temperature, end-of-cycle time and room/core temperature) <div style="float: right; font-size: small; margin-top: 10px;"> 10:54 19°C Stop 10:49 19°C Start Cella +3°C Hard Tempo ABB PROD AVICOLI Programma: 26 Data: 21/02/2005 ABBATTITORE FRODO </div>

CLOCK SETTING

See installation manual (page 30).



LANGUAGE

See installation manual (page 30).

ALARM

See installation manual (page 31).

SERVICE

See installation manual (page 33).

INPUTS/OUTPUTS

See installation manual (page 39).

- INSTRUCTION MANUAL -

MAINTENANCE

CHAPTER 4

MAINTENANCE AND CLEANING

CLEANING THE CABINET

Clean inside the cooling cabinet daily.

Both the cabinet and all the internal components have been designed and shaped to allow washing and cleaning all parts easily.

Before cleaning, defrost the appliance and remove the internal drain.

Disconnect the master switch.

Clean all components (stainless-steel, plastic or painted parts) with lukewarm water and detergent.

Then rinse and dry without using abrasives or chemical solvents. **(pict.8)**

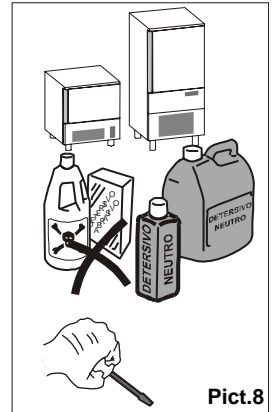

Do not wash the appliance by spraying high-pressure water on the machine. **(pict.9)**

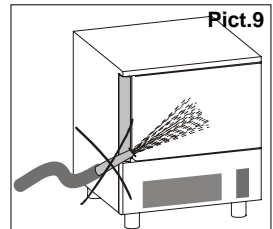

Do not rinse with sharp or abrasive tools, especially the evaporator. **(pict.10)**

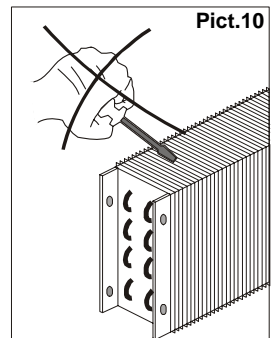

You may clean inside the evaporator after loosening the knobs and rotating the protection component. **(pict.11)**

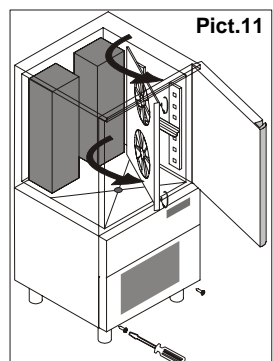

Remove the front control board with a tool and clean the raceway to remove all dirt. **(pict.12)**

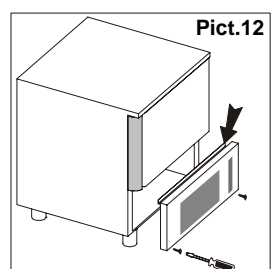

- INSTRUCTION MANUAL -

Wash the door gasket with water. Accurately dry with a dry cloth. We recommend wearing protecting gloves throughout the operations. (pict.13)

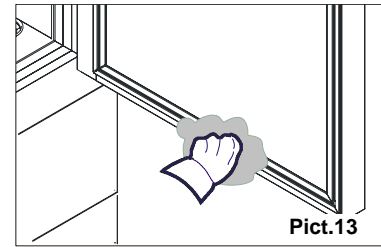

Hand-wash the probe using lukewarm water and a mild detergent or products with biodegradability higher than 90%. Rinse with water and sanitary solution. Do not use detergents containing solvents (such as trichloroethylene, etc) or abrasive powders

ATTENTION: do not use hot water to wash the probe (pict.14)

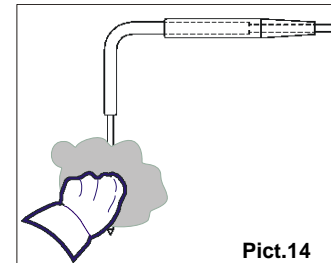

CLEANING THE AIR CONDENSER

The air condenser should be kept clean to ensure the appliance's performance and efficiency, as air should freely circulate inside the appliance. (pict.15)

The condenser should therefore be cleaned every 30 days, using non-metal brushes to remove all dust and dirt from condenser blades.

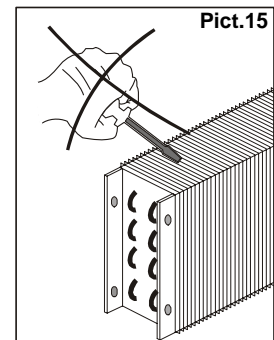

Access to the condenser is obtained by removing the front panel. (pict.16)

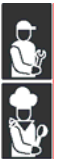
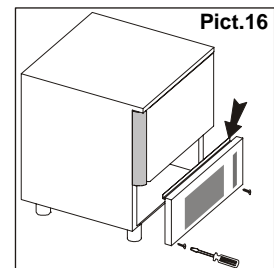

STAINLESS-STEEL MAINTENANCE

By stainless steel we mean INOX AISI 304 steel. We recommend following the instructions below for the maintenance and cleaning of stainless-steel parts. This is of the utmost importance to ensure the non-toxicity and complete hygiene of the processed foodstuffs. Stainless-steel is provided with a thin oxide layer which prevents it from rusting. However, some detergents may destroy or affect this layer, therefore causing corrosion. Before using any cleansing product, ask your dealer about a neutral chloriness cleansing product, as to avoid steel corrosions. If the surface has been scratched polish it with fine STAINLESS-STEEL wool or a synthetic-fibre abrasive sponge. Always rub in the direction of the silking. (pict.17)

WARNING: Never use iron wool for cleaning STAINLESS STEEL. Furthermore, avoid leaving iron wool on the appliance surface as tiny iron deposits may cause the surface to rust by contamination and affect the hygiene of the appliance.

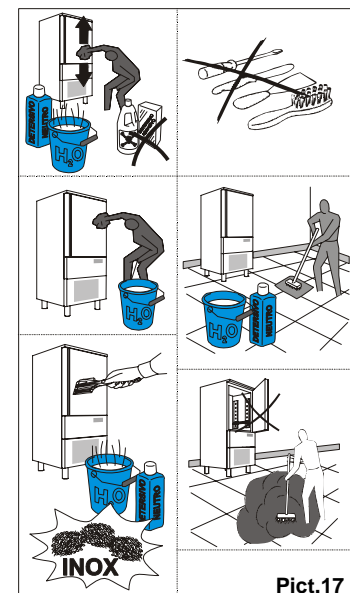

- INSTRUCTION MANUAL -

DISCONTINUED USE

Should the machine be disconnected over long periods, follow the instructions below to maintain the appliance in good condition:

Turn the mains switch OFF. (**pict.18**)

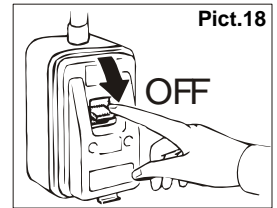

Disconnect the plug. (**pict.19**)

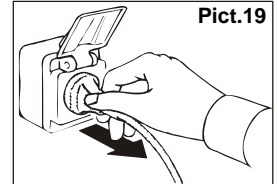

Empty the appliance and clean it in accordance with the instructions given in the chapter "CLEANING". Leave the door ajar to prevent a bad smell.

Cover the compressor unit with a nylon cloth to protect it from dust. (**pict.20**)

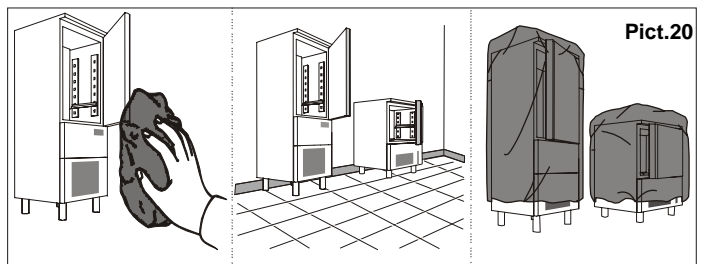

In case of appliances with remote control, if you decide to turn it off, remember to put the switch off also in the remote control.



- INSTALLATION MANUAL -

INSTALLATION

INTRODUCTION

After unpacking the appliance make sure it has not been damaged. **(pict.21)**
 Make sure the technical wiring specifications comply with the ratings (i.e., V, kW, Hz, no. phases and mains power). Check the power supply type, adjustments, performance and calibration of the device located before the appliance. Check and record the coolant type inside the system and refer to the recorded data in any refill.

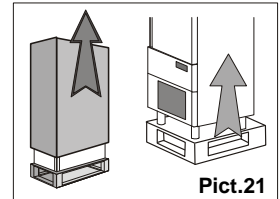

Pict.21

Please quote the product's serial number (shown on the rating plate) on any enquiry to the Manufacturer. **(pict.22)**

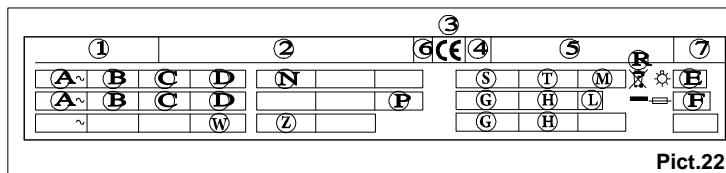

Pict.22

List of rates shown on the rating plate:

- | | |
|---|--|
| <ul style="list-style-type: none"> 1) Model 2) Manufacturer's name and address 3) CE mark 4) Year of make 5) Serial number 6) Power insulation class 7) Power protection class A) Input voltage B) Electric current intensity C) Frequency D) Rated power E) Total lamp power | <ul style="list-style-type: none"> F) Fuse current G) Coolant type H) Coolant q.ty L) Temperature grade M) Max hydraulic supply pressure N) Room temperature P) Expanding fluid R) WEEE Symbol S) Water inlet temperature T) Water consumption W) Heating unit power Z) Least pressure |
|---|--|



MAX ROOM TEMPERATURE (TAB.4)

Air-condenser units should not operate if room temperature is over 38°C. Above 32° C maximum output is not guaranteed.

The remote condensers must be installed outdoors out of direct sunlight or in suitable rooms. Always make sure that air ventilation is present. Check that suitable covers **(pict.23)** are used.

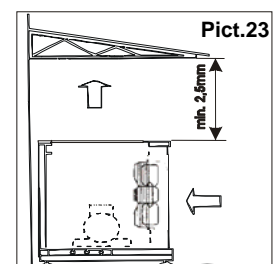

POSITIONING

The appliance must be installed and tested in full compliance with accident-prevention regulations contained in national law and current guidelines. Installers are to comply with any current local regulations.

- An omnipolar switch is to be installed before the appliance, in compliance with the current regulations applied in the country where the appliance is installed. **(pict.24)**

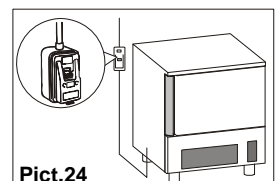

- INSTALLATION MANUAL -

- Do not place the refrigerated compartment near heat sources. (pict.25)

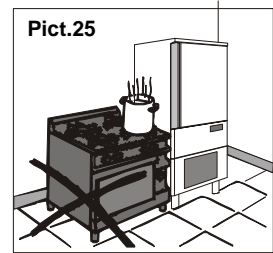

- Remove pvc protective film from all over the appliance. (pict.26)

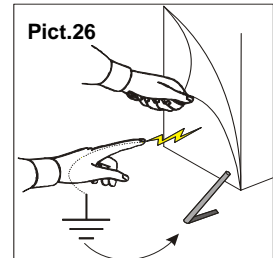

- Place the appliance onto the required working site. (pict.27)

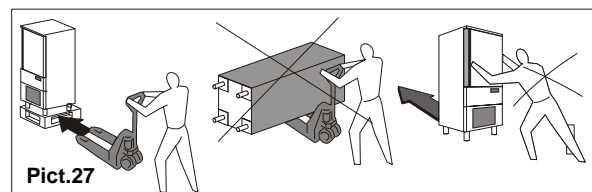

- Avoid locations with exposure to direct sunlight.
- Do not place the appliance in hot, poorly-ventilated rooms.

- Leave a min. 100-mm clearance around the appliance on the sides where air inlet and outlet are located. (pict.28)

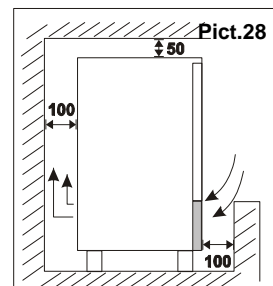

For models, depth 700, it is possible to bring the rear of the appliance closer to the wall.

- Level the appliance by means of adjustable feet. (pict.29)

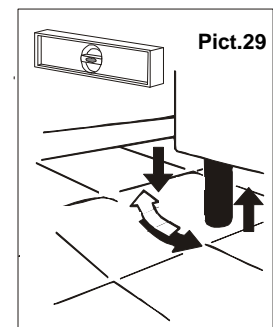

- In case of 72 kg and 144 kg blast chillers, set the handle moving the washers before or after the P plate. (pict.30)

- Use suitable fork lift trucks to level heavier appliances (20-kg models onwards).

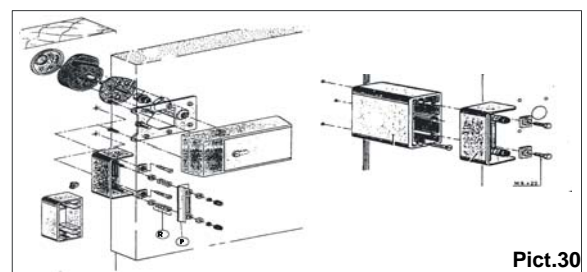

WARNING: If the appliance is not properly levelled the performance and condensate drain may be hampered.

- INSTALLATION MANUAL -

WIRING

The connection to power supply may be carried out at the back of the appliance after removing the protection grid. (pict.31)

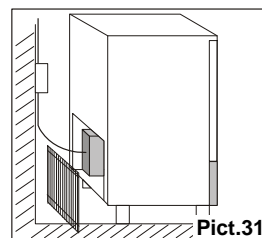

IMPORTANT: 10kg models are equipped with a 2-mt single-phase cable without plug. 20kg/30kg models are equipped with a 2-mt three-phase supply cable without plug. 40kg models are equipped with a 3.5m three-phase supply cable without plug.

In models with distance condenser the cabinet and the unit (pict.32) must be connected separately.

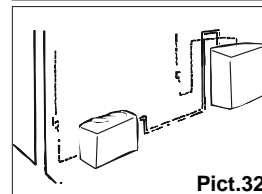

Remove the electric board panel to access the cabinet terminal board. Open the lateral panel of the electrical board (pict.33) in the condenser.

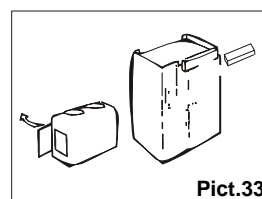

PLEASE USE CERTIFIED APPROVED MATERIALS

All wiring cables are to comply with the ratings shown on the technical specifications.

Cables are to be connected to the equipotential terminal. (pict.34)

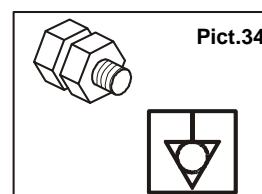

The grounding cable is to be directly connected to a good grounding system. (pict.35)

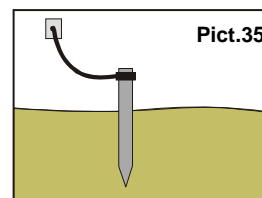

CONNECTION TO CONDENSATE DRAIN

On certain models, a condensation discharge \varnothing 30mm hose installation is necessary, "SAREL" or any similar type). The current general and local regulations as to drains are to be complied with. (pict.36)

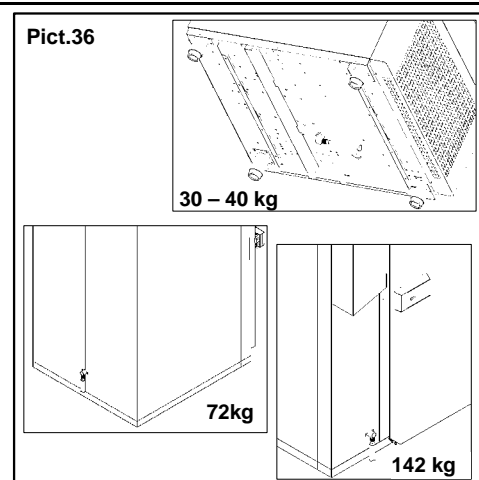

The guarantee will cease and the Manufacturer will not be liable for any damage to appliances or operators arising from the non-compliance with the and tamperings to any part of the appliance (electric, thermodynamic or hydraulic plant).

- INSTALLATION MANUAL -









TESTING

Carry out the following checkings:

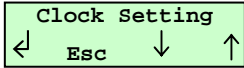
- 1) Outside temperatures must be included between 10°C and 43°C.
- 2) Turn on the appliance and wait 30 minutes before the use if the external temperature is "low".
- 3) Check power input.
- 4) Carry out at least one full quick cooling cycle

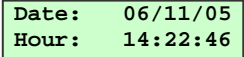

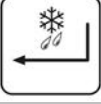

Should the appliance have been transported horizontally instead of a vertical position DO NOT START THE APPLIANCE IMMEDIATELY. WAIT FOR AT LEAST 4 HOURS BEFORE OPERATING.

CLOCK SETTING



	Press menu/esc to select the desired menu
	Use the keys up and down to display 
	Press enter to gain access to the clock setting mode The display shows 
	Use the keys up and down to change the flashing digit
	Press enter to confirm and pass to the next value
	Press menu/esc several times to exit

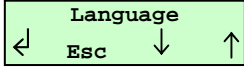
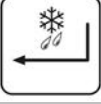
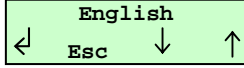









LANGUAGE

	Press menu/esc to select the desired menu
	Use the keys up and down to display 
	Press enter to display the first language available 
	Use the keys up and down to select the desired language

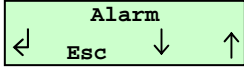
- INSTALLATION MANUAL -

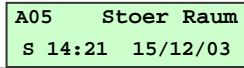
	Press enter to confirm your choice
	Press menu/esc several times to exit

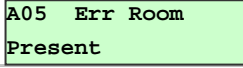
ALARMS AND FAULT ANALYSIS (TAB.5)

	Press menu/esc to select the desired menu
	Use the keys up and down to display 
	<p>Press enter to gain access to the mode for displaying alarms</p> <p>If there are no alarms memorized, the display shows </p> <p>If there are alarms memorized, the display shows the last alarm starting time as well as the progressive number ranging from A01 to A30 </p>
	<p>Press enter to get further information about the alarm. The max. or min. temperature, the duration, call SERVICE, the alarm de-activation time or the indication that the alarm is still in progress.</p> 
	Use the keys up and down to display all the memorized alarms
	Press menu/esc several times to exit



If the fault is not corrected by following the above instructions ask for skilled assistance and avoid carrying out any other operations, especially on the electricals. When informing the servicing company of the fault, state **1** and **5** numbers (**pict.37**)

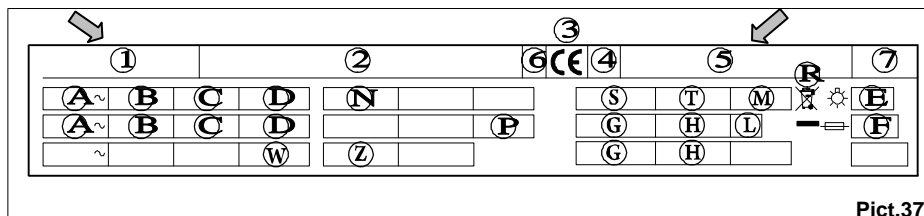

- INSTALLATION MANUAL -

TAB.5

FAULT	CAUSE	REMEDY
No voltage on Anomalous stop	No power supply Blown fuse Loosened connections	Restore power supply Replace fuses Check connection fitting
Compressor failure	High and Low-pressure pressure-switch on Clicker on Contactor failure Compressor thermal relay on	Ask for skilled assistance Ask for skilled assistance Ask for skilled assistance Ask for skilled assistance
The compressor is working but the cabinet is not cooling	Frosted evaporator No coolant inside the refrigerating system Delivery solenoid valve failure	Open the door and carry out defrost cycle Ask for skilled assistance Ask for skilled assistance
Evaporator fans are not working	Fan failure or short-circuit Door micro failure	Ask for skilled assistance Ask for skilled assistance
The cycle cannot start	Wrong cycle programming	Check time and temperature parameters
AL High Press	Pressostat intervention	Qualified technician required
AL Room Probe	Room Probe interrupted	Qualified technician required
AL Evap Probe	Evap Probe interrupted	Qualified technician required
AL Cond Probe	Cond Probe interrupted	Qualified technician required
AL Needle Probe	Needle Probe interrupted	If a probe cycle is running, the cycle is time-controlled Qualified technician required
AL Insert Needle	Needle Probe not inserted	Check the probe inserting cone
High T Room	Room Temp above set value	If the temperature is not within the specified range, apply to a qualified technician
Low T Room	Room Temp below set value	If the temperature is not within the specified range, apply to a qualified technician
AL BlackOut	No power supply	When power is restored, check the max. temperature reached inside the room
AL Door Open	QC room door open Door micro faulty	Close the door Qualified technician required



- INSTALLATION MANUAL -

SERVICE

PARAMETERS

DESCRIPTION OF PARAMETERS

Parameter	Description	Default (IS...)	Default (IA...)	Default (DS...)	min	MAX
POSITIVE QUICK COOLING						
P01	Room SetPoint in pos. quick cooling, Soft phase	-5°C	-5°C	-5°C	-30°C	30°C
P02	SetPoint cella in abbattimento Hard	-25°C	-25°C	-25°C	-40°C	30°C
P03	Needle SetPoint in pos. quick cooling , Soft phase	3°C	3°C	3°C	-30°C	30°C
P04	Needle SetPoint in Hard quick coolong	20°C	20°C	20°C	-30°C	30°C
P05	Positive quick cooling duration	90min	90min	90min	0min	900min
P06	Hard phase duration expressed as % in relation to P05	60%	60%	60%	0%	100%
P07	Room SetPoint in pos. storing	2°C	2°C	2°C	-30°C	30°C
NEGATIVE QUICK COOLING						
N01	Room SetPoint in neg, quick cooling	-25°C	-25°C	-25°C	-40°C	30°C
N02	Needle SetPoint in neg. quick cooling	-18°C	-18°C	-18°C	-30°C	30°C
N03	Negative quick cooling duration	240min	240min	240min	0min	900min
N04	Room SetPoint in neg. storing	-22°C	-22°C	-22°C	-40°C	30°C
ALARMS						
A01	Temperature alarm hysteresis	2°C	2°C	2°C	0°C	10°C
A02	High temperature limit alarm in pos. storing in relation to P07	10°C	10°C	10°C	0°C	50°C
A03	Low temperature limit alarm in pos. storing in relation to P07	-10°C	-10°C	-10°C	-50°C	0°C
A04	High temperature limit alarm in neg. storing in relation to N04	10°C	10°C	10°C	0°C	50°C
A05	Low temperature limit alarm in neg. storing in relation to N04	-10°C	-10°C	-10°C	-50°C	0°C
A06	Temperature alarm delay from storing or defrost start	60min	60min	60min	0min	300min
A07	Temperature alarm delay	30min	30min	30min	0min	300min
A08	Duration of the buzzer in the alarm mode	1min	1min	1min	0min	240min
DISPLAY						
D01	Temperature unit of measurement (0 Celsius; 1 Fahrenheit)	0	0	0	0	1
D02	Room probe Offset	0°C	0°C	0°C	-10°C	10°C
D03	BackLight (0 on when pressing a key; 1 always on)	1	1	1	0	1
D04	Heart probe offset	-7°C	-7°C	-7°C	-10°C	10°C
D05	Subcutaneous probe offset	-7°C	-7°C	-	-10°C	10°C
D06	External probe offset	-7°C	-7°C	-	-10°C	10°C
DEFROST						
S01	Performs defrost on quick cooling start 0 = No; 1 = Yes	0	0	0	0	1
S02	End-of-defrost temperature	8°C	8°C	8°C	-10°C	30°C
S03*	Defrost max. duration	15 min	15 min	15 min	1 min	90 min
S04	Interval between defrosts in storing (0=excluded)	0 ore	0 ore	0 ore	0	18 ore
S05*	Type of defrost: 0= electrical or due to compressor stop 1= hot gas 2= air	2	2	2	0	2
S06*	Dripping time	1 min	1 min	1 min	0 min	90 min
S07	Compressor activation delay with hot gas defrost	0 sec	0 sec	0 sec	0 sec	600 sec
S08	First defrost activation time from storing start (0=excluded)	0	0	0	0	90 min
S09	Ignores compressor protection delays in defrost	0	0	0	0	1



- INSTALLATION MANUAL -

Parameter	Description	Default (IS...)	Default (IA...)	Default (DS...)	min	MAX
S10*	Defrost type started through keyboard: 0= electrical or due to compressor stop 1= hot gas 2= air	2	2	2	0	2
CONFIGURATION						
C01	Door input (0 de-activated; 1 activated)	1	1	1	0	1
C02	Door open polarity	0	0	0	0	1
C03	Door open alarm delay	2 min	2 min	2 min	0 min	60 min
C04	Activates buzzer (0 de-activated; 1 activated)	1	1	1	0	1
C05	Buzzer duration at the end of quick cooling cycle	10 sec	10 sec	10 sec	0	600 sec
C06	Temperature difference in the first phase of needle insertion test (0 = test excluded)	7°C	7°C	7°C	0	60°C
C07	Duration of the second phase of needle insertion test (0=test excluded)	56 sec	56 sec	56 sec	0	600 sec
C08*	Activates condenser probe 0 = no probe 1 = probe	1	1	1	0	1
C09	Compressor stop delay due to door opening	30 sec	30 sec	30 sec	0 sec	60 sec
C10	Pressostat alarm detection time	5 sec	5 sec	5 sec	0 sec	60 sec
C11	High pressure digital input polarity	0	0	0	0	1
C12	Resistances starting SetPoint	-5°C	-5°C	-5°C	-10°C	20°C
ADJUSTMENT						
R01	Compressor start/stop hysteresis	2°C	2°C	2°C	0°C	20°C
R02	Min. interval between 2 compressor starting	2 min	2 min	2 min	0 min	30 min
R03	Compressor start delay from card activation	0 sec	0 sec	0 sec	0 sec	300 sec
R04	Compressor Duty-Cycle time with faulty room probe in storing	10 min	10 min	10 min	0 min	90 min
R05	Compressor ON time faulty room in pos. storing	3 min	3 min	3 min	0 min	90 min
R06	Compressor ON time with faulty room in neg. storing	8 min	8 min	8 min	0 min	90 min
R07	Needle min. temperature for starting quick cooling	70°C	70°C	70°C	0°C	90°C
R08	Compressor inhibition temperature	90°C	90°C	90°C	0°C	100°C
R09	Compressor Protection function activation time	24 ore	24 ore	24 ore	0 ore	240 ore
R10	Pulse duration	2 sec	2 sec	2 sec	1 sec	10 sec
R11	Pause between pulses	4 sec	4 sec	4 sec	1 sec	10 sec
R12	Number of pulses	3	3	3	1	20
R13	Temperature at the end of the Cooling cycle	-25°C	-25°C	-25°C	-50°C	10°C
STERILIZATION						
U01	Sterilization duration	20 min	20 min	20 min	1 min	99 min
FANS						
F01	Evaporator fans activation hysteresis	2°C	2°C	2°C	0°C	20°C
F02	Condenser fans activation hysteresis	2°C	2°C	2°C	0°C	20°C
F03	Evaporator fans activation SetPoint	5°C	5°C	5°C	-50°C	50°C
F04	Condenser fans activation SetPoint	15°C	15°C	15°C	-50°C	50°C
F05	Evaporator fans during defrost 0 = fans OFF; 1 = fans ON	0	0	0	0	1
F06	Condenser fans during defrost 0 = fans OFF; 1 = fans ON	0	0	0	0	1
F07*	Fans stop time after defrost	1 min	1 min	1 min	0 min	30 min
F08	Condenser fans stop delay	30 sec	30 sec	30 sec	0 sec	300 sec
F09	Evaporator fans control during quick cooling: 0 = fans always ON 1 = fans thermostated by evaporator temperature	0	0	0	0	1
F10	Evaporator fans control during storing: 0 = fans in parallel with the compressor 1 = fans thermostated by evaporator temperature	0	0	0	0	1



- INSTALLATION MANUAL -

Parameter	Description	Default (IS...)	Default (IA...)	Default (DS...)	min	MAX
F11*	Evaporator fans inhibition temperature	70°C	70°C	70°C	0°C	90°C
PRINT						
PR1	Sampling time	10 min	10 min	10 min	1 min	60 min
VENTILATION SPEED (P.W.M.)						
CF1	Evaporator fan min. speed	30	30	-	0	100
CF2	Evaporator fan min. speed selectable in a quick cooling cycle	50	50	-	0	100
I.F.R.						
B01	Room thermostating temperature in the first phase	-45°C	-45°C	-	-50°C	+50°C
B02	Subcutane T control start temperature	5°C	5°C	-	-50°C	+99°C
B03	First coefficient of the control relation	0	0	-	-50	+50
B04	Second coefficient of the control relation	0	0	-	-50	+50
B05	Third coefficient of the control relation	-8	-8	-	-50	+50
B06	Subcutane T initial value determining the end of the first phase	-1°C	-1°C	-	-50°C	+99°C
B07	Phase two formula coefficient	99	99	-	0	+99
B09	Subcutane t min. value allowed during the third phase	0	0	-	-50°C	+99°C
B10	End of intelligent quick cooling core temperature	4°C	4°C	-	-50°C	+99°C
B11	Delay from the positive result of the needle test for starting the procedure to determine the end of the first phase	60 sec	60 sec	-	0 sec	+99 sec
B12	First phase temperature detection time	30 sec	30 sec	-	0 sec	+99 sec
B13	First phase min. duration	6 min	6 min	-	0 min	+99min
B16	Defrost on starting intell. QC cycle (0=no 1=yes)	0	0	-	0	1
B17	Inhibition temperature	90°C	90°C	-	-50°C	+99°C
B18	Room Set point in the event of automatic switch to time or temperature mode	-7°C	-7°C	-	-50°C	+99°C
B19	Max. duration possible for intelligent QC process	999 min	999 min	-	1 min	999 min
B20	Subcutane T safety value determining the end of the first phase	-1°C	-1°C	-	-50°C	+99
B21	First coefficient of the room thermostating curve (third phase)	10	10	-	-90	+99
B22	Second coefficient of the room thermostating curve (third phase)	-50	-50	-	-90	+99
B23	Storing activation at the end of intell. QC cycle (0 = no; 1 = yes)	1	1	-	0	1
B24	Room thermostating Set-point in storing	2°C	2°C	-	-90°C	+90°C
B26	Core temperature limit for the timer start	999	999	-	0	+999
B27	Adjuster of fans speed in the third phase	99	99	-	0	+99
B28	Cold pulse adjuster	10	10	-	0	+99
COMMUNICATION						
ADD	Device Address	1	1	1	1	147
SC	Serial Control : 0 = not activated 1 = print 2 = ModBus (RS485)	1	1	1	0	2
MB1	BaudRate: 0 = 2400; 1 = 4800; 2 = 9600; 3 = 18200	2	2	2	0	3
MB2	Parity: 0 = no parity; 1 = odd; 2 = even	2	2	2	0	2
TYPE OF CYCLE						
G01	Positive QC cycles only : 0 = Positive and Negative 1 = Positive only	0	0	0	0	1



* In IS models... with remote assembly, replace the default value of the following parameters:













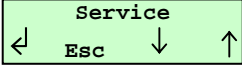

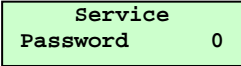
C08 = 0;

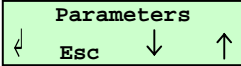
In **ISR201R** and **ISR202R** models, replace the default value of the following parameters:

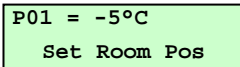
S03 = 30 min.; S05 = 0; S06 = 7 min.; S10 = 0; C08 = 0; F07 = 5 min.; F11 = 65°C

- INSTALLATION MANUAL -



CHANGING PARAMETERS

	Press menu/esc to select the desired menu
	Use the keys up and down to display 
	Press enter to confirm your choice. The display shows  (only the 1st time)
	Use the keys up and down to select the password “-19”
	Press enter to confirm your choice. The display shows 
	Press enter to gain access to the parameter programming mode The first parameter is displayed 
	Use the keys up e down to scroll all the controller parameters
	Press enter to confirm your choice
	Use the keys up e down to select the new value of the parameter
	Press enter to confirm your choice
	Press menu/esc several times to exit



RESET MEMORY

This function cancels the memorised data, but not the memorised user's programmes.

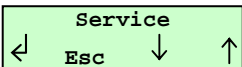
	Press menu/esc to select the desired menu
	Use the keys up and down to display 

- INSTALLATION MANUAL -

	Press enter to confirm your choice.
	The display shows Service Password 0 (only the 1st time)
	Use the keys up and down to select the password “-19”
	Press enter to confirm your choice.
	The display shows Parameters Esc ↓ ↑
	Use the keys up and down to display Reset Memory Esc ↓ ↑
	Press enter to gain access to the mode for cancelling the data stored in the memory
	The display shows Reset Memory? Ok No
	Press Enter to cancel the whole memory
	Press menu/esc several times to exit

RESTORE



This function restores the original parameters.

ATTENTION: should you use the device with the “RESTORE” option, available on the card, please apply to the manufacturer for proper setting of the electronic controller configuration parameters.









	Press menu/esc to select the desired menu
	Use the keys up and down to display Service Esc ↓ ↑
	Press enter to confirm your choice.
	The display shows Service Password 0 (only the 1st time)
	Use the keys up and down to select the password “-19”
	Press enter to confirm your choice.
	The display shows Parameters Esc ↓ ↑
	Use the keys up and down to display Restore Esc ↓ ↑
	Press enter to gain access to the mode for cancelling the data stored in the memory
	The display shows Restore? Ok No

- INSTALLATION MANUAL -

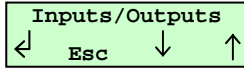
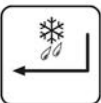
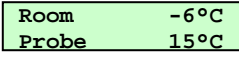
	Press Enter to cancel the whole memory
	Press menu/esc several times to exit

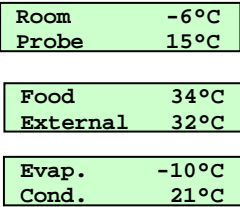
INPUTS/OUTPUTS

	Press menu/esc to select the desired menu
	Use the keys up and down to display 
	Press enter to gain access to the mode for displaying inputs and outputs The display shows 
	Use the keys up and down to scroll the data to display  Room and Needle temperature values Rod temperature value Evaporator and Condenser temperature values Outputs state Digital inputs state and evaporator fan speed
	Press menu/esc several times to exit

C	Compressor	R	Door resistance
D	Defrost	A	Alarm
FE	Evaporator fan	DI1	Inputs state micro
FC	Condenser fan	DI2	Inputs state thermostat
L	Sterilisation	FAN	Evaporator fan speed

STERILIZATION LAMP INSTALLATION

The sterilization lamp kit is not supplied as standard equipment.
Should you purchase the kit, please follow the installation instructions to install.

PRINTER INSTALLATION

The printer is not supplied as standard equipment .
Should you purchase the printer, please follow the installation instructions to install.

- INSTALLATION MANUAL -

MAINTENANCE OF PANEL BOARD

The following operations are to be carried out by skilled staff only.

Turn the mains switch OFF. (**pict.38**)

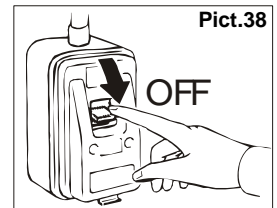

Disconnect the plug. (**pict.39**)

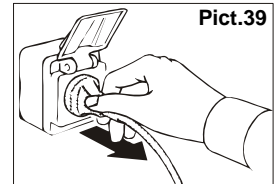

To be able to access the electric picture:

Mod. 10Kg

Remove the front panel (**pict.40**) with a tool and move the electric board box (**pict.41**) along the slides

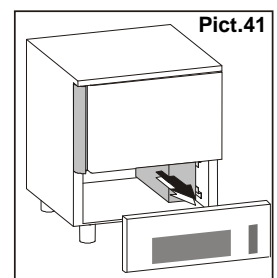
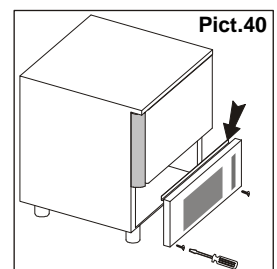

Remove the electrical board cover with a tool to access the internal components.
Two delayed fuses are inserted in the power supply line.
For replacement remove the cover by unscrewing the fixing screws, extract the blown fuse and replace it with a fuse having the same characteristics. (**pict.42**)

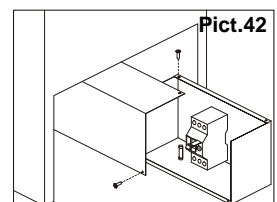

Mod. 20Kg-30Kg-40Kg

Remove the front panel (**pict.43**) and the control panel by means of a suitable tool.

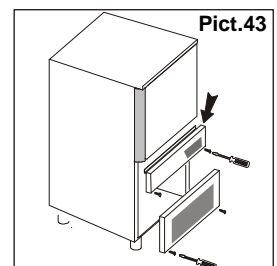

Remove the cover to have access to the components using a suitable tool (**pict.44**).

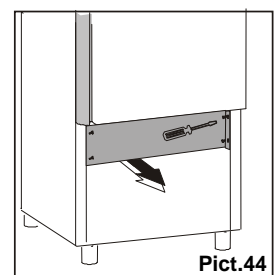

- INSTALLATION MANUAL -

Two delayed fuses are inserted in the power supply line; extract the blown fuse and replace it with a fuse having the same characteristics. (pict.45)

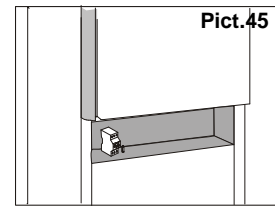

Mod. 72Kg-144Kg

Remove the electrical board cover with a tool to access the internal components from above.

Two delayed fuses are inserted in the power supply line. For replacement remove the cover by unscrewing the fixing screws, extract the blown fuse and replace it with a fuse having the same characteristics. (pict.46)

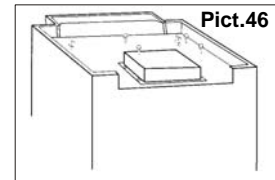

WIRING DIAGRAM PLATE

The diagram is shown on pict.47.

CONTROL AND SAFETY SYSTEMS

The following information concerns skilled staff only:

- **Door micro-switch:** Prevents the appliance from working when the door is open
- **Overall protection fuses:** Protect the whole power circuit from and short-circuits and overloads
- **Compressor thermal relay:** Operates in case of an overload or working failures
- **Motor-fan thermal relay:** Operates in case of an overload or working failures
- **Safety pressure-switch:** Operates in case of coolant over-pressure
- **Cabinet temperature control:** Is run by NTC probe through the relevant electronic card
- **Core temperature control:** Is run by PT100 probe through an electronic card
- **Controlled substances leakage:** appliances with a content of coolant exceeding 3 kg should be checked for leakage yearly



DISPOSAL

WASTE STORAGE

At the end of the product life, avoid release to the environment. The doors should be removed before disposal. Temporary storage of special waste is permitted while waiting for disposal by treatment and/or final collection. Dispose of special waste in accordance with the laws in force with regard to protection of the environment in the country of the user.

PROCEDURE FOR ROUGH DISMANTLING THE APPLIANCE

All countries have different legislation; provision laid down by the laws and the authorised bodies of the countries where the demolition takes place are therefore to be observed. A general rule is to deliver the appliance to specialised collection and demolition centres. Dismantle the refrigerator grouping together the components according to their chemical nature. The compressor contains lubricating oil and refrigerant, which may be recycled. The refrigerator components are considered special waste, which can be assimilated with domestic waste. Make the appliance totally unusable by removing the power cable and any door locking mechanisms in order to avoid the risk of anyone being trapped inside.

DISMANTLING OPERATIONS SHOULD BE CARRIED OUT BY QUALIFIED PERSONNEL.

THE SAFE DISPOSAL OF WASTE FROM ELECTRICAL AND ELECTRONIC EQUIPMENT (WEEE DIRECTIVE 2002/96/EC)

Do not dump pollutant material in the environment. Dispose of it in compliance with the relevant laws.

- INSTALLATION MANUAL -

Under the WEEE (Waste Electrical and Electronic Equipment) Directive 2002/96/EC, when scrapping equipment the user must dispose of it at the specific authorised disposal centres, or reassign it, still installed, to the original seller on purchase of new equipment.

All equipment which must be disposed of in accordance with the WEEE Directive 2002/96/EC is marked with a special symbol .

The improper disposal of Waste Electrical and Electronic Equipment is liable to punishment under the relevant laws in the countries where the offence is committed.

Waste electrical and Electronic Equipment may contain hazardous substances with potential harmful effects on the environment and human health. You are urged to dispose of them properly.

REFRIGERANT MATERIAL SAFETY DATA SHEET

1) **R404a**: fluid components

- trifluoroethane (HFC 143a) 52%
- pentafluoroethane (HFC 125) 44%
- tetrafluoroethane (HFC 134a) 4%

GWP = 3750

ODP = 0

2) Hazard identification

Overexposure through inhalation may cause anaesthetic effects. Acute overexposure may cause cardiac rhythm disorders and sudden death. Product mists or sprays may cause ice burns of eyes and skin.

3) First aid procedures

- *Inhalation*: keep injured person away from exposure, warm and relaxed. Use oxygen, if necessary. Give artificial respiration if respiration has stopped or is about to stop. In case of cardiac arrest give external cardiac massage. Seek immediate medical attention.
- *Skin*: use water to remove ice from affected areas. Remove contaminated clothes.
CAUTION: clothes may adhere to skin in case of ice burns.
In case of contact with skin, wash with copious quantities of lukewarm water. In case of symptoms (irritation or blisters) seek medical attention.
- *Eyes*: immediately wash with ocular solution or fresh water, keeping eyelids open for at least 10 minutes. Seek medical attention.
- *Ingestion*: it can cause vomit.. If conscious, rinse mouth with water and drink 200-300 ml of water. Seek medical attention.

Other medical treatment: symptomatic treatment and support therapy when indicated. Do not administer adrenaline or sympatheticomimetic drugs after exposure, due to the risk of arrhythmia and possible cardiac arrest.

4) Environmental data

Persistence and degradation

- *HFC 143a*: slow decomposition in lower atmosphere (troposphere). Duration in atmosphere is 55 years.
- *HFC 125*: slow decomposition in lower atmosphere (troposphere). Duration in atmosphere is 40 years.
- *HFC 134a*: relatively rapid decomposition in lower atmosphere (troposphere). Duration in atmosphere is 15.6 years.
- *HFC 143a, 125, 134a*: does not affect photochemical smog (not included in volatile organic components – VOC – as established in the UNECE agreement). Does not cause ozone rarefaction.

Product exhausts released in the atmosphere do not cause long-term water contamination.



- INSTALLATION MANUAL -

DIMENSIONS

Please refer to the dimensions of your own appliance.

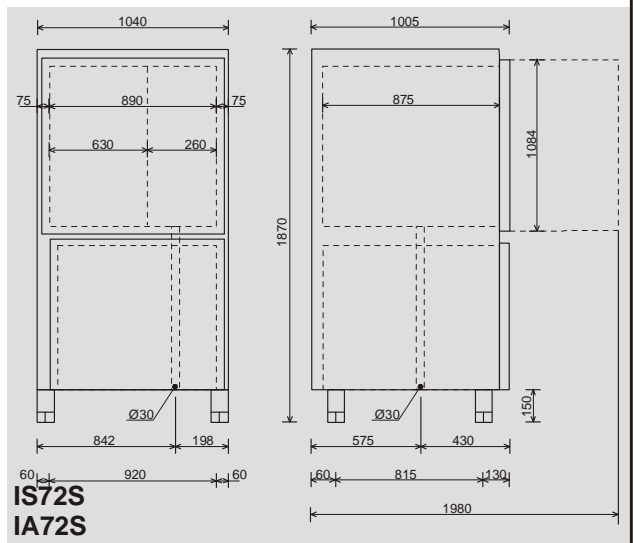
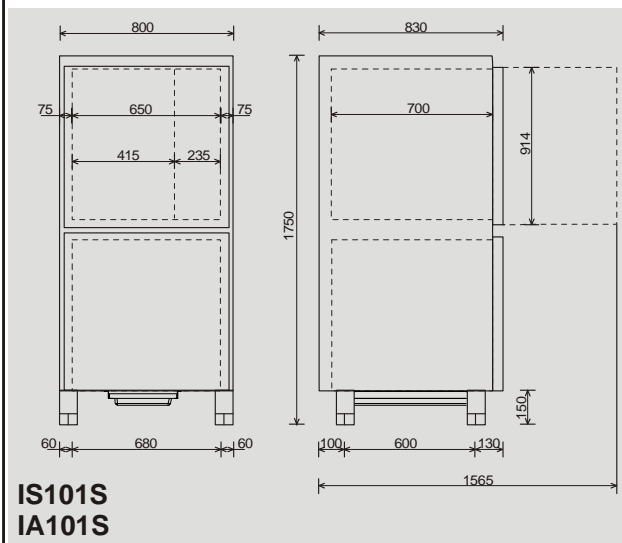
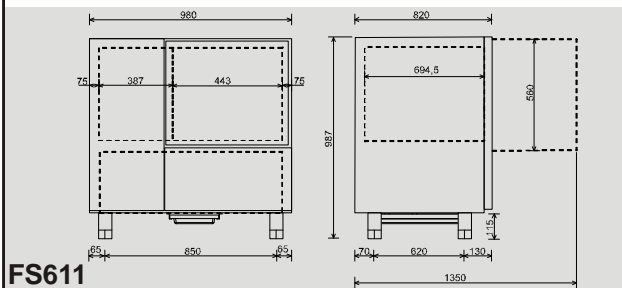
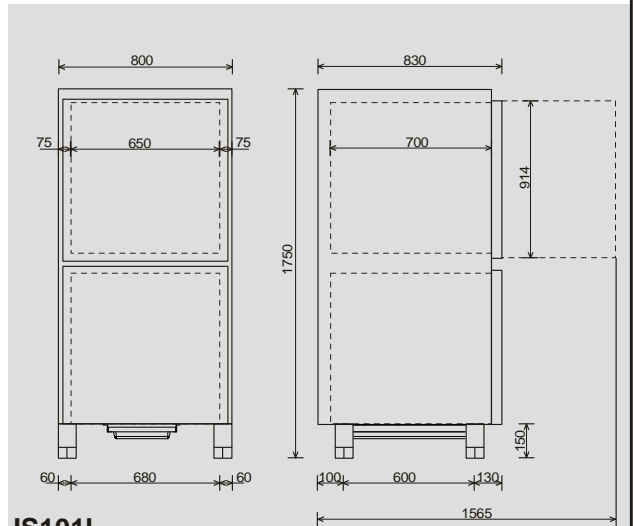
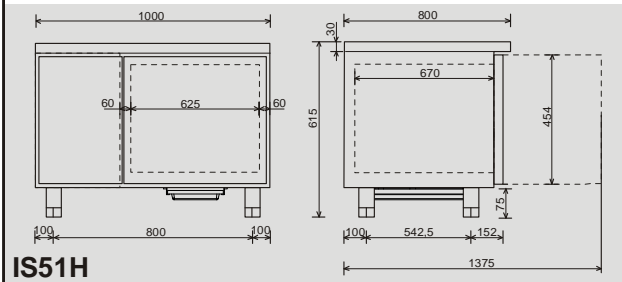
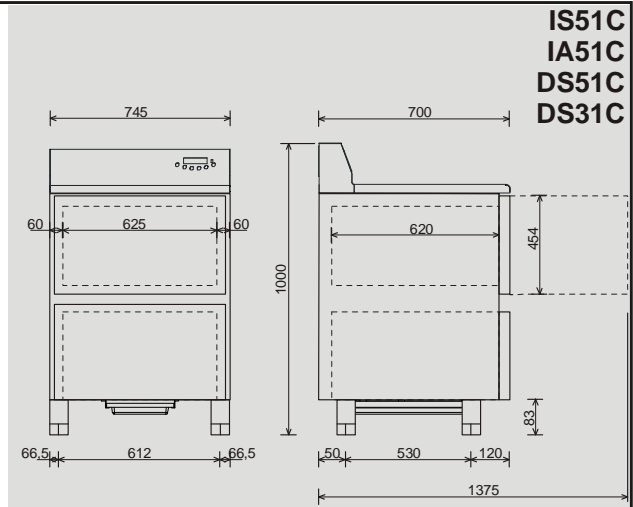
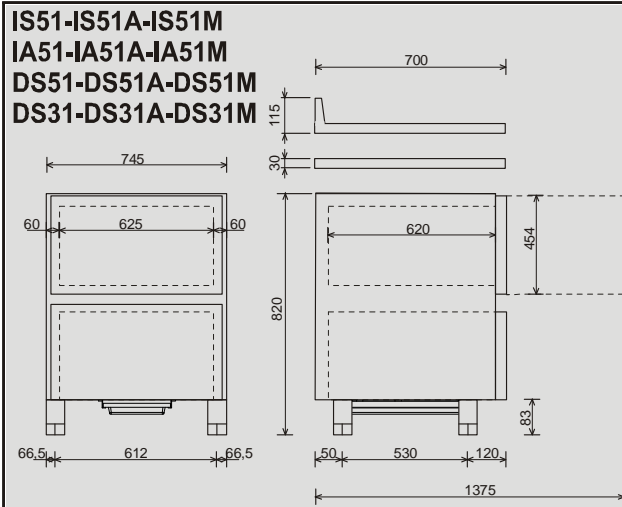

- INSTALLATION MANUAL -

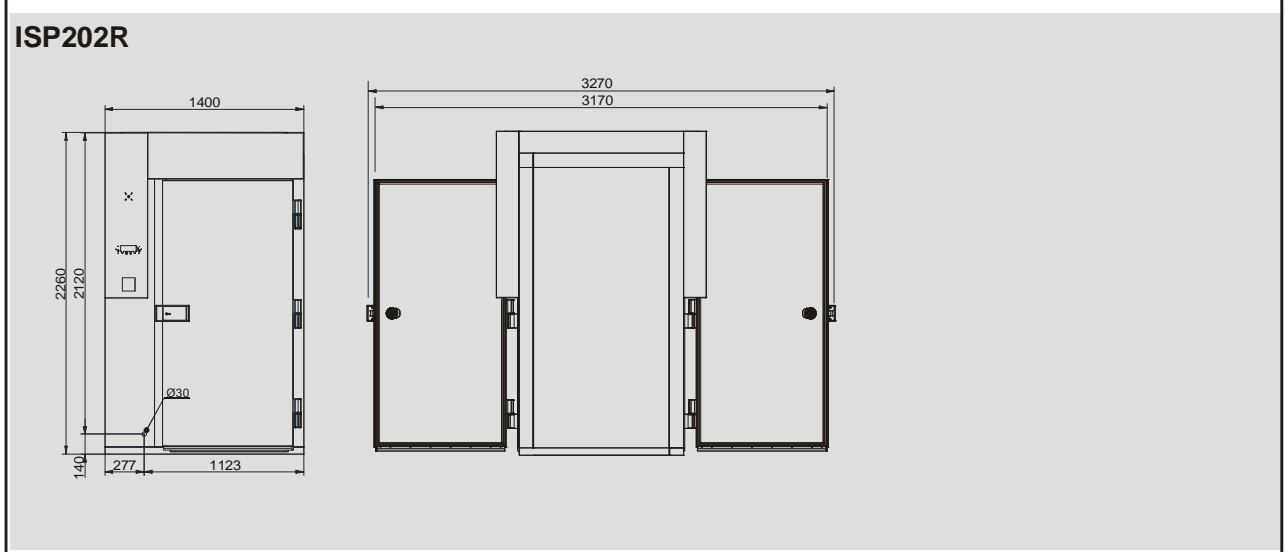
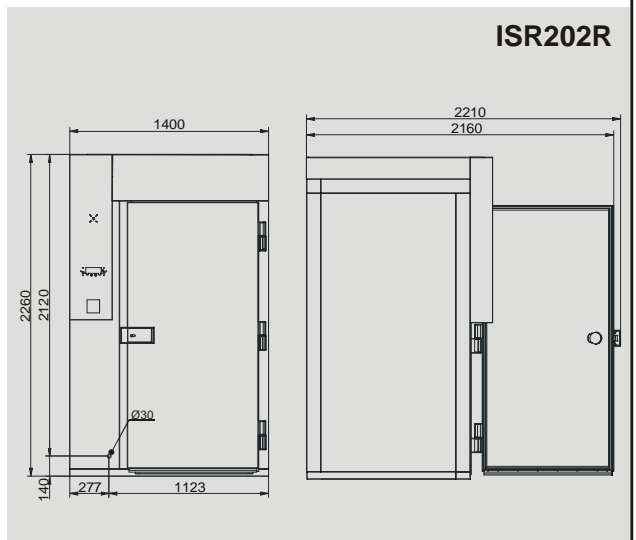
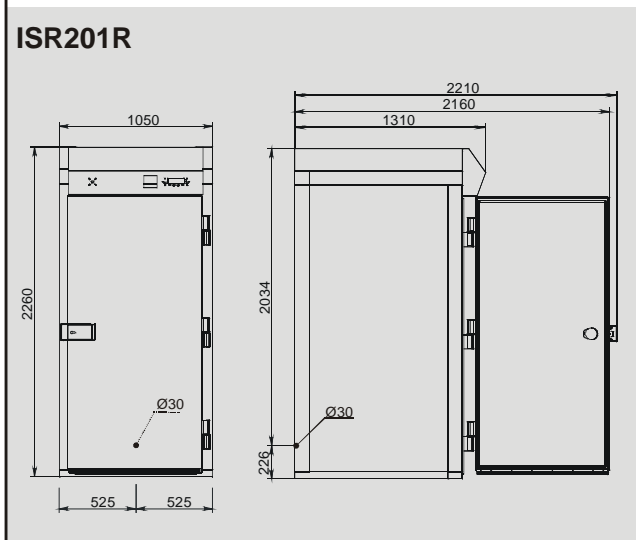
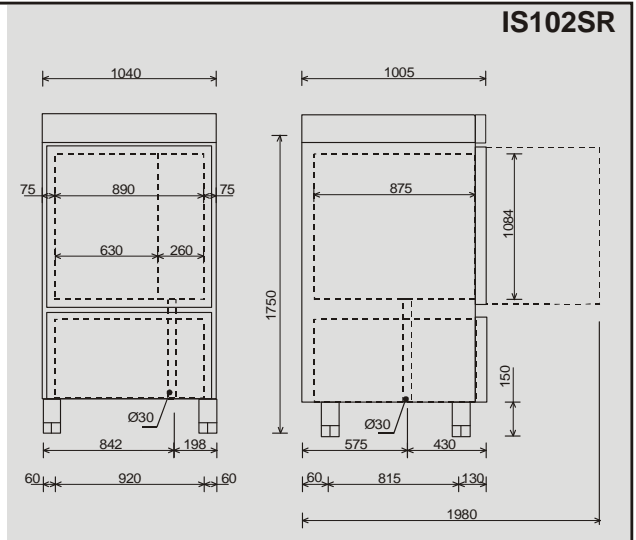
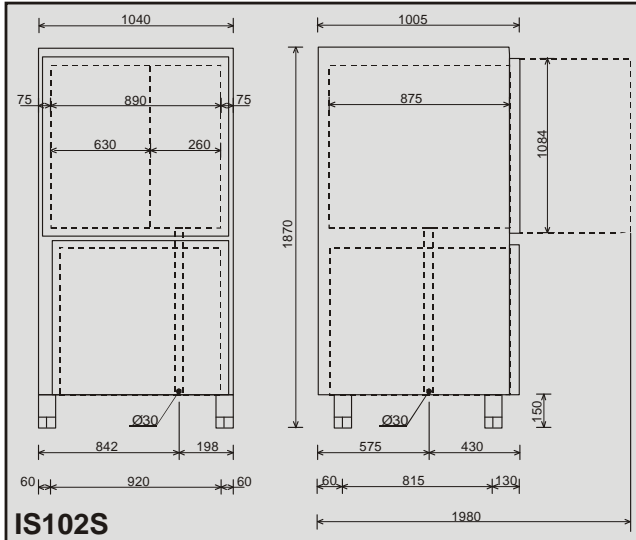

- INSTALLATION MANUAL -

ANNEXES

TAB.1a

Model	IS51-IS51A IS51M-IS51C (10Kg)	IS51H (10Kg)	FS611 (20Kg)	IS101L (20Kg L)	IS101S (20Kg S)	IS72S (30Kg)	IS102S (40Kg)	IS102SR (40Kg R)	ISR201R (72Kg)	ISR202R ISP202R(*) (144Kg)
Gross weight	125	125	195	220	220	250	320	320	380	500
Net weight	115	115	180	195	195	220	290	290	280	360
Dimensions	745x700x820 /850/935/1000	1000x860 x615	980x820 X987	800x830 x1750	800x830 x1750	1040x1005 x1870	1040x1005 x1870	1040x1005 x1750	1050x1310 x2260	1400x1310 x2260 (*)1400x1470 x2260
Capacity										
Mass /cycle [kg]	10	10	20	20	20	25	40	40	72	144
Internal volume [l]	90	90	190	195	195	480	480	480	1900	2800
Rails	GN1/1 600x400	GN1/1 600x400	GN1/1 600x400	GN1/1 600x400	GN1/1 600x400	GN2/1 600x800	GN2/1 600x800	GN2/1 600x800	GN1/1 600x400	GN1/1 600x400
Trays	5	6	6	10	10	10	10	10	20	20
Power supply										
Voltage [V]	230 ~	230 ~	400 3N	400 3N	400 3N	400 3N	400 3N	400 3N	230 ~	230 ~
Frequency [Hz]	50	50	50	50	50	50	50	50	50	50
Intensity [A]	6,2	6,2	8	6	6	6,5	10	10	4	5,4
Power input [W]	1350	1350	1968	3200	3200	3600	5500	5500	850 [3000]	1200 [4500]
Refrigerating unit										
Refrigerating power [W]	617	617	600	2011	2011	2011	2400	2400	5070	9710
Evaporation temperature [°C]	-30	-30	-30	-30	-30	-30	-30	-30	-30	-30
Cooling temperature [°C]	+90÷+3	+90÷+3	+90÷+3	+90÷+3	+90÷+3	+90÷+3	+90÷+3	+90÷+3	+90÷+3	+90÷+3
Cooling time [min]	90	90	90	90	90	90	90	90	90	90
Freezing temperature [°C]	+90÷-18	+90÷-18	+90÷-18	+90÷-18	+90÷-18	+90÷-18	+90÷-18	+90÷-18	+90÷-18	+90÷-18
Freezing time [min]	240	240	240	240	240	240	240	240	240	240
Condensation temperature [°C]	+54,5	+54,5	+45	+54,5	+54,5	+54,5	+54,5	+54,5	+54,5	+54,5
Max room temperature [°C]	+32	+32	+32	+32	+32	+32	+32	+32	+43	+43
Compressor type	Ermetic	Ermetic	Semiermetic	Ermetic	Ermetic	Ermetic	Ermetic	Ermetic	Ermetic	Ermetic
Coolant	R404a	R404a	R404a	R404a	R404a	R404a	R404a	R404a	R404a	R404a
Coolant qty [g]	1400	1400	2700	2000	2000	2300	3500	3500	1000	2000
Condensation air	Air	Air	Air	Air	Air	Air	Air	Air	Air	Air
Noise [dB] (A)	65	65	72	72	72	72	72	72	72	72
IFR	•	•	•	•	•	•	•	•	•	•
Multi-detector probe	•	•	•	•	•	•	•	•	•	•

Cooling time increases by 20% if the machine is leaning against the wall.

- INSTALLATION MANUAL -

TAB.1b

Model	IA51-IA51A-IA51M- IA51C (10Kg)	IA101L (20Kg L)	IA101S (20Kg S)	IA72S (30Kg)	DS31-DS31A-DS31M- DS31C (10Kg)	DS51-DS51A-DS51M- DS51C (10Kg)
Gross weight	125	220	220	250	125	125
Net weight	115	195	195	220	115	115
Dimensions	745x700x820/850/935/ 1000	800x830x1750	800x830x1750	1040x1005x1870	745x700x820/850/935/ 1000	745x700x820/850/935/ 1000
Capacity	10	20	20	25	10	10
Mass /cycle [kg]	90	195	195	480	90	90
Internal volume [l]	GN1/1 600x400	GN1/1 600x400	GN1/1 600x400	GN2/1 600x800	GN1/1 600x400	GN1/1 600x400
Rails	5	10	10	10	3	5
Power supply						
Voltage [V]	230 ~	400 3N	400 3N	400 3N	230 ~	230 ~
Frequency [Hz]	50	50	50	50	50	50
Intensity [A]	4	4,5	4,5	4,5	3,5	6,2
Power input [W]	850	2200	2200	2500	680	1350
Refrigerating unit						
Refrigerating power [W]	692	2245	2245	3325	577	617
Evaporation temperature [°C]	-10	-10	-10	-10	-23,3	-30
Cooling temperature [°C]	+90÷+3	+90÷+3	+90÷+3	+90÷+3	+90÷+3	+90÷+3
Cooling time [min]	90	90	90	90	90	90
Freezing temperature [°C]	-	-	-	-	+90÷-18	+90÷-18
Freezing time [min]	-	-	-	-	240	240
Condensation temperature [°C]	+54,5	+54,5	+54,5	+54,5	+54,5	+54,5
Max room temperature [°C]	+32	+32	+32	+32	+32	+32
Compressor type	Ermetic	Ermetic	Ermetic	Ermetic	Ermetic	Ermetic
Coolant	R404a	R404a	R404a	R404a	R404a	R404a
Coolant qty [g]	1000	1800	1800	2000	450	1400
Condesation air	Air	Air	Air	Air	Air	Air
Noise [dB] (A)	65	72	72	72	65	65
IFR	•	•	•	•		
Single-detector probe					•	•
Multi-detector probe	•	•	•	•		

Cooling time increases by 20% if the machine is leaning against the wall.

TAB.4

Min. air circulation

Model	Air q.ty [m ³ /h]
10 kg	1.100
20 kg	3.500
25 kg	4.300
40 kg	9.000
70 kg	9.000
144 kg	13.500

- INSTALLATION MANUAL -

Pict.47



N°	DESCRIPTION	N°	DESCRIPTION
1	COMPRESSOR	67B	EVAPORATOR FAN RUN CAPACITOR
2	CONDENSER FAN	69	GROUND TERMINAL
2A	THERMOSTATED CONDENSER FAN	70	HIGH PRESSURE PRESSOSTAT
3	TERMINAL BOARD	70A	HIGH PRESSURE PRESSOSTAT
3A	TERMINAL BOARD	73	FUSE-HOLDER WITH UNIPOLAR FUSE
9	1-SPEED EVAPORATOR FAN	75	ELECTROVALVE
9A	1-SPEED EVAPORATOR FAN	76	MAGNETIC MICROSWITCH
9B	1-SPEED EVAPORATOR FAN	77	COMPARTMENT PROBE
12	DEFROST ELECTROVALVE	78	EVAP./DEFROST PROBE
20	DOOR ANTICONDENSATE RESISTANCE	79	NEEDLE CORE PROBE
20A	DOOR ANTICONDENSATE RESISTANCE	79A	MULTIPOINT NEEDLE CORE PROBE
21	DEFROST RESISTANCE	80	PTC RESISTANCE FOR COMPRESSOR CASING
21A	DEFROST RESISTANCE	85A	BOX WITH TERMINAL BOARD (EVAP.)
21B	DEFROST RESISTANCE	85B	BOX WITH TERMINAL BOARD (COND.)
21C	DEFROST RESISTANCE	86	CONDENSER PROBE
22	BOWL BOTTOM RESISTANCE	97	LCD QUICK COOLER CARD
65	CONTACTOR	92	THERMAL PRINTER
66	THERMAL RELAY	94	DISCONNECTOR
67	EVAPORATOR FAN RUN CAPACITOR	97A	EVAP. FAN CHOKE MODULE.
67A	EVAPORATOR FAN RUN CAPACITOR	97B	EVAP. FAN CHOKE MODULE