

INDUSTRIAL TUMBLE DRYERS

55kg

77kg

90kg

INSTALLATION, OPERATION, MAINTENANCE

70476501ENR7
Publication date: Jan 2014

Front Matter

Installation must conform with local codes or, in the absence of local codes, with:

In the U.S.A., installation must conform to the latest edition of the American National Standard Z223.1/ NFPA 54 “National Fuel Gas Code” and Standard ANSI/NFPA 70 “National Electric Code.”

In Canada, installation must comply with Standards CAN/CSA-B149.1 or Natural Gas and Propane Installation Code and CSA C22.1, latest edition, Canadian Electric Code, Part I.

In Australia and New Zealand, installation must comply with the Gas Installations Standard AS/NZS 5601 Part 1: General Installations.



WARNING

FOR YOUR SAFETY, the information in this manual must be followed to minimize the risk of fire or explosion or to prevent property damage, personal injury or death.

W033



WARNING

- Do not store or use gasoline or other flammable vapors and liquids in the vicinity of this or any other appliance.
- **WHAT TO DO IF YOU SMELL GAS:**
 - Do not try to light any appliance.
 - Do not touch any electrical switch; do not use any phone in your building.
 - Clear the room, building or area of all occupants.
 - Immediately call your gas supplier from a neighbor’s phone. Follow the gas supplier’s instructions.
 - If you cannot reach your gas supplier, call the fire department.
- Installation and service must be performed by a qualified installer, service agency or the gas supplier.

W052

IMPORTANT: Information must be obtained from a local gas supplier on instructions to be followed if the user smells gas. These instructions must be posted in a prominent location. Step-by-step instructions of the above safety information must be posted in a prominent location near the tumble dryer for customer use.

IMPORTANT: The installer must fully test the tumble dryer after installation and demonstrate to the owner how to operate the machine.



WARNING

To reduce the risk of electric shock, fire, explosion, serious injury or death:

- Disconnect electric power to the tumble dryer before servicing.
- Close gas shut-off valve to gas tumble dryer before servicing.
- Close steam valve to steam tumble dryer before servicing.
- Never start the tumble dryer with any guards/panels removed.
- Whenever ground wires are removed during servicing, these ground wires must be reconnected to ensure that the tumble dryer is properly grounded.

W002R1



WARNING

- Installation of unit must be performed by a qualified installer.
- Install tumble dryer according to manufacturer's instructions and local codes.
- **DO NOT** install a tumble dryer with flexible plastic venting materials. If flexible metal (foil type) duct is installed, it must be of a specific type identified by the appliance manufacturer as suitable for use with tumble dryer. Refer to section on connecting exhaust system. Flexible venting materials are known to collapse, be easily crushed, and trap lint. These conditions will obstruct tumble dryer airflow and increase the risk of fire.

W752R1

The following information applies to the state of Massachusetts, USA.

- This appliance can only be installed by a Massachusetts licensed plumber or gas fitter.
- This appliance must be installed with a 36 inch (91 cm) long flexible gas connector.
- A "T-Handle" type gas shut-off valve must be installed in the gas supply line to this appliance.
- This appliance must not be installed in a bedroom or bathroom.

Table of Contents

Introduction.....	8
Model Identification.....	8
Contact Information.....	9
Safety Information.....	10
Safety Information.....	10
Important Safety Instructions.....	10
Specifications and Dimensions.....	12
Specifications and Dimensions.....	12
120 Series Tumble Dryer Dimensions and Exhaust Outlet Locations.....	14
170 and 200 Series Tumble Dryer Dimensions and Exhaust Outlet Locations.....	16
Electric and Gas Connection Locations for Gas Models Through 3/10/13.....	18
Electric and Gas Connection Locations for Gas Models Starting 3/11/13.....	19
Electric and Steam Connection Locations for Steam Models Through 3/10/13.....	20
Electric and Steam Connection Locations for Steam Models Starting 3/11/13.....	22
Electric Connection Location for Electric Models.....	24
Installation.....	25
Pre-Installation Inspection.....	25
Location Requirements.....	25
Position and Level the Tumble Dryer.....	27
Fire Suppression System (Optional Equipment).....	28
Check Local Codes and Permits.....	28
Water Requirements.....	28
Water Connections.....	28
Electrical Requirements.....	30
Auxiliary Alarm.....	30
Before Placing Tumble Dryer into Service.....	30
Required for CE Models Only.....	32
Installing CE Gas Drying Tumble Dryer.....	32
General Information.....	32
CE Orifices.....	33
Properties of CE Gases.....	34
Changing Gas Configuration.....	35
Specific Conversion Procedures.....	36
Exhaust Requirements.....	38

Exhaust Requirements.....	38
Layout.....	38
Make-Up Air.....	38
Venting.....	38
Alternate Venting for 120 Series Tumble Dryers.....	40
Individual Venting.....	40
Manifold Venting.....	41
Gas Requirements.....	44
Gas Requirements.....	44
Gas Supply Pipe Sizing and Looping.....	46
High Altitude Orifice Sizing.....	48
Electrical Requirements.....	51
Electrical Requirements.....	51
Wiring Diagram.....	51
Grounding Instructions.....	51
For CE Models Only.....	52
Service/Ground Location.....	52
To Connect Electrical Service To The Tumble Dryer.....	54
Jumper Configuration Instructions.....	54
Ferrite Ring Installation.....	54
Electrical Specifications.....	56
Steam Requirements.....	60
Steam Requirements.....	60
Piping Recommendations.....	64
Installing Steam Trap and Making Condensate Return Connections.....	64
Thermal Oil Prep.....	64
Operating Instructions.....	65
Operating Instructions.....	65
Emergency Stop Button On CE Models.....	65
Operating Instructions.....	65
Reversing Operation.....	66
Control Instructions.....	66
Dual Digital Timer Control.....	66
Electronic OPL Micro Control.....	68
LED OPL Control.....	70
Ignition Control Operation and Troubleshooting for Models Starting 3/11/13.....	71
Internal Control Failure.....	72
Troubleshooting.....	72
Proper Electrode Location.....	73
Flame Current Measurement.....	73
Ignition Control Operation for Non-CE Models Through 3/10/13.....	73
Ignition Control Operation for CE Models Through 3/10/13.....	74
System Tests.....	74
Diagnostic LED (DGN LED)/Error Codes.....	75

Adjustments.....	76
Adjustments.....	76
Gas Burner Air Shutter.....	76
Airflow Switch.....	76
Loading Door Switch.....	77
Loading Door Catch (120 and 170 Series Models).....	77
Loading Door Strike (200 Series Models).....	77
Belt Drive.....	78
Maintenance.....	80
Daily.....	80
Monthly.....	80
Quarterly.....	80
Bi-Annually.....	80
Annually.....	81
Fire Suppression System (Optional Equipment) Maintenance Test.....	81
Before You Call for Service.....	83
Removing Tumble Dryer from Service.....	84
Disposal of Unit.....	85

Introduction

Model Identification

Information in this manual is applicable to these models:

	Gas			Steam/Thermal Oil		Electric
120 Series	GA120L GA120N GK120N GT120L GT120N GU120L GU120N KA120L KA120N KK120N	KT120L KT120N KU120L KU120N LA120L LA120N LK120N LT120L LT120N LU120L	LU120N PA120L PA120N PK120N PT120L PT120N PU120L PU120N	GT120S GT120T GU120S GU120T KT120S KT120T KU120S KU120T	LT120S LT120T LU120S LU120T PT120S PT120T PU120S PU120T	GT120E GU120E KT120E KU120E LT120E LU120E PT120E PU120E
170 Series	GA170L GA170N GK170N GT170L GT170N GU170L GU170N KA170L KA170N KK170N	KT170L KT170N KU170L KU170N LA170L LA170N LK170N LT170L LT170N LU170L	LU170N PA170L PA170N PK170N PT170L PT170N PU170L PU170N	GT170S GT170T GU170S GU170T KT170S KT170T KU170S KU170T	LT170S LT170T LU170S LU170T PT170S PT170T PU170S PU170T	Not Applicable
200 Series	LA200L LA200N LT200L LT200N	LU200L LU200N PA200L PA200N	PT200L PT200N PU200L PU200N	LT200S LT200T LU200S LU200T	PT200S PT200T PU200S PU200T	Not Applicable

Explanation of digit in 6th position of model number:

E = Electric
L = Liquid Petroleum (L.P.) Gas
N = Natural Gas

S = Steam
T = Thermal Oil

Includes models with the following control suffixes:

RE – reversing LED OPL	RM – reversing OPL micro	RQ – reversing dual digital timer
------------------------	--------------------------	-----------------------------------

Contact Information

If service is required, contact the nearest Factory Authorized Service Center.

If you are unable to locate an authorized service center or are unsatisfied with the service performed on your unit, contact the source from which you purchased your unit.

When calling or writing about your unit, PLEASE GIVE THE MODEL AND SERIAL NUMBERS. The model and serial numbers are located on the nameplate. The nameplate will be in the location shown in *Figure 1*.

Date Purchased _____

Model Number _____

Serial Number _____

Please include a copy of your bill of sale and any service receipts you have.

	WARNING
<p>To reduce the risk of serious injury or death, DO NOT repair or replace any part of the unit or attempt any servicing unless specifically recommended in the user-maintenance instructions or in published user-repair instructions that you understand and have the skills to carry out.</p>	
W329	

If replacement parts are required, contact the source from where you purchased your tumble dryer.

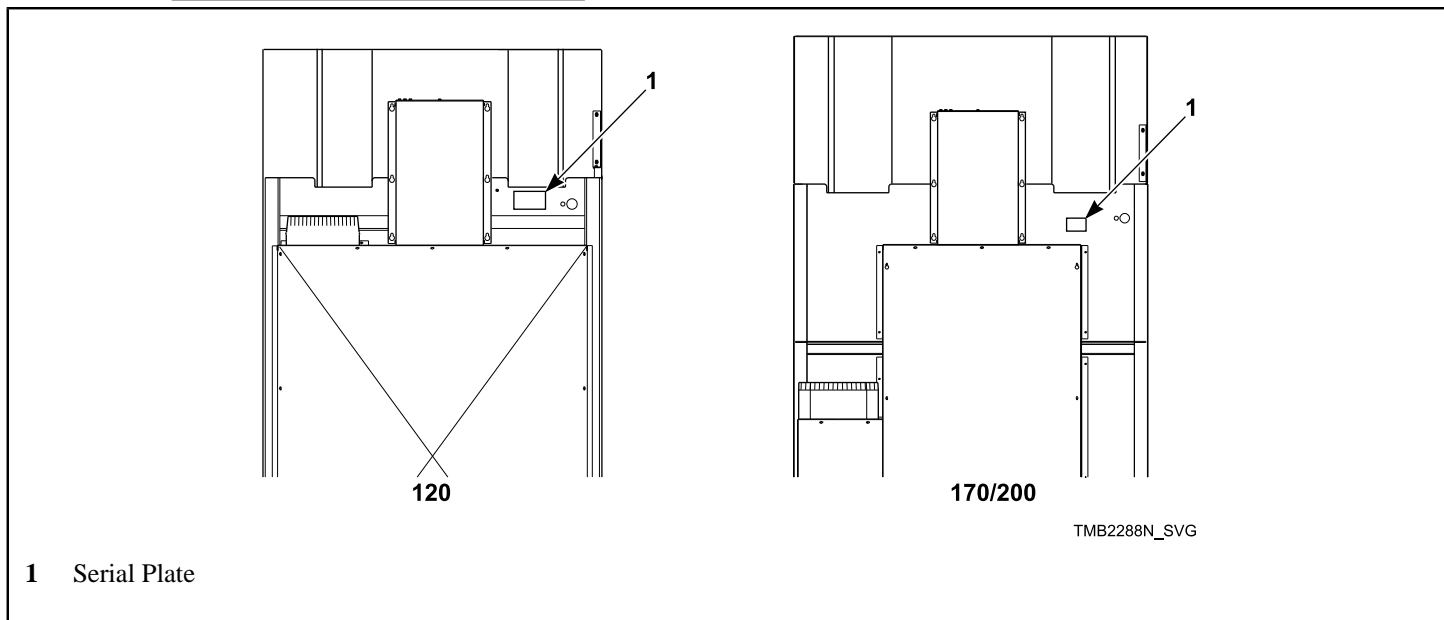



Figure 1

Safety Information

Safety Information

Precautionary statements (“DANGER,” “WARNING,” and “CAUTION”), followed by specific instructions, are found in this manual and on machine decals. These precautions are intended for the personal safety of the operator, user, servicer, and those maintaining the machine.

	DANGER
Indicates an imminently hazardous situation that, if not avoided, will cause severe personal injury or death.	

	WARNING
Indicates a hazardous situation that, if not avoided, could cause severe personal injury or death.	

	CAUTION
Indicates a hazardous situation that, if not avoided, may cause minor or moderate personal injury or property damage.	

Additional precautionary statements (“IMPORTANT” and “NOTE”) are followed by specific instructions.

IMPORTANT: The word “IMPORTANT” is used to inform the reader of specific procedures where minor machine damage will occur if the procedure is not followed.

NOTE: The word “NOTE” is used to communicate installation, operation, maintenance or servicing information that is important but not hazard related.

	WARNING
Failure to install, maintain, and/or operate this machine according to manufacturer’s instructions may result in conditions which can produce serious injury, death and/or property damage.	
W051R1	

NOTE: The **WARNING** and **IMPORTANT** instructions appearing in this manual are not meant to cover all possible conditions and situations that may occur. It must be understood that common sense, caution and carefulness are factors which **CANNOT** be built into this tumble dryer. These factors **MUST BE** supplied by the person(s) installing, maintaining or operating the tumble dryer.

Always contact your dealer, distributor, service agent or the manufacturer on any problems or conditions you do not understand.

Important Safety Instructions

	WARNING
To reduce the risk of fire, electric shock, serious injury or death to persons when using your tumbler, follow these basic precautions.	
W776	

Save These Instructions

- Read all instructions before using the tumble dryer.
- Install the tumble dryer according to the **INSTALLATION** instructions. Refer to the **EARTHING** (grounding) instructions for the proper earthing (grounding) of the tumble dryer. All connections for electrical power, earthing (grounding) and gas supply must comply with local codes and be made by licensed personnel when required. It is recommended that the machine be installed by qualified technicians.
- Do not install or store the tumble dryer where it will be exposed to water and/or weather. The tumble dryer cannot be used in a closed room where the air supply is insufficient. If necessary, ventilation grids must be installed in the doors or the windows.
- This appliance must not be activated without lint/foam filter.
- When you perceive a gas odor, immediately switch off the gas supply and ventilate the room. Do not switch on electrical appliances and do not pull electrical switches. Do not use matches or lighters. Do not use a phone in the building. Warn the fitter, and if so desired, the gas company, as soon as possible.
- To avoid fire and explosion, keep surrounding areas free of flammable and combustible products. Regularly clean the dryer drum and exhaust tube should be cleaned periodically by competent maintenance personnel. Daily remove piled up dust from filter and inside of filter compartment.
- Do not use or store flammable materials near this appliance.

- Do not dry articles that have been previously cleaned in, washed in, soaked in or spotted with gasoline or machine oils, vegetable or cooking oils, cleaning waxes or chemicals, dry-cleaning solvents, thinner or other flammable or explosive substances as they give off vapors that could ignite, explode or cause fabric to catch on fire by itself.
- Do not spray aerosols in the vicinity of this appliance while it is in operation.
- Items such as foam rubber (latex foam), shower caps, waterproof textiles, rubber backed articles and clothes or pillows filled with foam rubber pads should not be dried in the tumble dryer. Do not use the appliance to dry materials with a low melting temperature (PVC, rubber, etc.).
- Do not tumble fiberglass curtains and draperies unless the label says it can be done. If they are dried, wipe out the cylinder with a damp cloth to remove particles of fiberglass.
- Do not allow children on or in the tumble dryer. This appliance is not intended for use by young children or infirm persons without supervision. Young children should be supervised to ensure that they do not play with the appliance.
- Do not reach into the tumble dryer if the cylinder is revolving.
- Use tumble dryer only for its intended purpose, drying fabrics. Always follow the fabric care instructions supplied by the textile manufacturer and only use the dryer drum to dry textiles that have been washed in water. Only insert spin-dried linen in the dryer.
- Always read and follow manufacturer's instructions on packages of laundry and cleaning aids. Heed all warnings or precautions. To reduce the risk of poisoning or chemical burns, keep them out of the reach of children at all times (preferably in a locked cabinet).
- Do not use fabric softeners or products to eliminate static unless recommended by the manufacturer of the fabric softener or product.
- Remove laundry immediately after tumble dryer stops.
- DO NOT operate the tumble dryer if it is smoking, grinding or has missing or broken parts or removed guards or panels. DO NOT tamper with the controls or bypass any safety devices.
- Tumble dryer will not operate with the loading door open. DO NOT bypass the door safety switch to permit the tumble dryer to operate with the door open. The tumble dryer will stop tumbling when the door is opened. Do not use the tumble dryer if it does not stop tumbling when the door is opened or starts tumbling without pressing or turning the START mechanism. Remove the tumble dryer from use and call for service.
- Tumble dryer(s) will not operate with lint panel open. DO NOT bypass lint panel safety switch to permit the tumble dryer to operate with the lint panel open.
- Do not modify this appliance.
- Always clean the lint filter daily. Keep area around the exhaust opening and adjacent surrounding area free from the accumulation of lint, dust and dirt. The interior of the tumble dryer and the exhaust duct should be cleaned periodically by qualified service personnel.
- Solvent vapors from dry-cleaning machines create acids when drawn through the heater of the drying unit. These acids are corrosive to the tumble dryer as well as the laundry load being dried. Be sure make-up air is free of solvent vapors.
- At the end of each working day, close off all main supplies of gas, steam and current.
- Do not repair or replace any part of the tumble dryer, or attempt any servicing unless specifically recommended in the user-maintenance instructions or in published user-repair instructions that the user understands and has the skills to carry out. ALWAYS disconnect and lockout the electrical power to the tumble dryer before servicing. Disconnect power by shutting off appropriate breaker or fuse.
- Before the tumble dryer is removed from service or discarded, remove the door to the drying compartment and the door to the lint compartment.
- Failure to install, maintain, and/or operate this tumble dryer according to the manufacturer's instructions may result in conditions which can produce bodily injury and/or property damage.

NOTE: The WARNINGS and IMPORTANT SAFETY INSTRUCTIONS appearing in this manual are not meant to cover all possible conditions and situations that may occur. Common sense, caution and care must be exercised when installing, maintaining, or operating the tumble dryer.

Always contact your dealer, distributor, service agent or the manufacturer on any problems or conditions you do not understand.

Specifications and Dimensions

Specifications and Dimensions

Specifications		120 Series	170 Series	200 Series
Noise level measured during operation at operator position of 3.3 feet (1 meter) in front of machine and 5.2 feet (1.6 meters) from floor.		66 dBA	66 dBA	66 dBA
Cylinder Size: Inches (mm)		44 x 41 (1,118 x 1,041)	50.75 x 42.5 (1,289 x 1,080)	50.75 x 50 (1,289 x 1,270)
Cylinder Capacity dry weight: Pounds (kg)		120 (54.4)	170 (77.1)	200 (90.7)
Standard Packaging Weight: Pounds (kg)	Gas and Electric	1,338 (607)	1,667 (756)	1,718 (779)
	Steam	1,446 (656)	1,776 (806)	1,818 (825)
Standard Packaging Shipping Dimensions: Inch (mm)		48.5 x 72 x 90 (1,232 x 1,829 x 2,286)	58 x 74.5 x 99 (1,473 x 1,892 x 2,515)	56 x 80 x 99 (1,422 x 2,032 x 2,515)
Slat Crate Packaging Weight: Pounds (kg)	Gas and Electric	1,447 (656)	1,791 (812)	1,868 (848)
	Steam	1,547 (702)	1,891 (858)	1,968 (893)
Slat Crate Shipping Dimensions: Inch (mm)		51.5 x 74 x 90.75 (1,308 x 1,880 x 2,305)	61 x 76.5 x 99.75 (1,549 x 1,943 x 2,534)	61 x 83 x 101 (1,549 x 2,108 x 2,565)
Cylinder Motor: HP (kW)		0.75 (0.560)	0.75 (0.560)	0.75 (0.560)
Fan Motor: HP (kW)		1 (0.746)	3 (2.238)	3 (2.238)
Air Outlet Diameter: Inches (mm)		10 (254)	12 (300)	12 (300)
Maximum Static Back Pressure: W.C.I. (mbar, kPa)		0.8 (2.0, 0.2)	0.8 (2.0, 0.2)	0.8 (2.0, 0.2)
Maximum Airflow: C.F.M. (L/sec.)		1,600 (755)	2,450 (1,156)	2,450 (1,156)
Gas Models				

Specifications	120 Series	170 Series	200 Series
Net Weight (approximate): Pounds (kg)	1,275 (578)	1,575 (716)	1,707 (774)
Gas Connection	Models through 3/10/13: 3/4 in. NPT Models Starting 3/11/13: 1 in. NPT	1 in. NPT	1 in. NPT
Gas Burner Rating: Btu/hr. (Mj/hr., kW)	270,000 (285, 79.13)	395,000 (417, 115.77)	425,000 (448, 124.56)
Steam Models			
Net Weight (approximate): Pounds (kg)	1,375 (624)	1,675 (761)	1,807 (820)
Steam Connection	3/4 in. NPT inlet 3/4 in. NPT outlet	3/4 in. NPT inlet 1 in. NPT outlet	3/4 in. NPT inlet 1 in. NPT outlet
Steam Coil Rating at 100 psig: Btu/hr. (kg/hr.) (recommended operating pressure 80-100 psig)	405,000 (183.1)	648,000 (294.2)	648,000 (294.2)
Electric Models			
Heating Element Rating: Kilowatts (kW)	60 kW	Not Applicable	Not Applicable

NOTE: All machines are shipped with extra nipple to convert to metric thread (from Standard).

120 Series Tumble Dryer Dimensions and Exhaust Outlet Locations

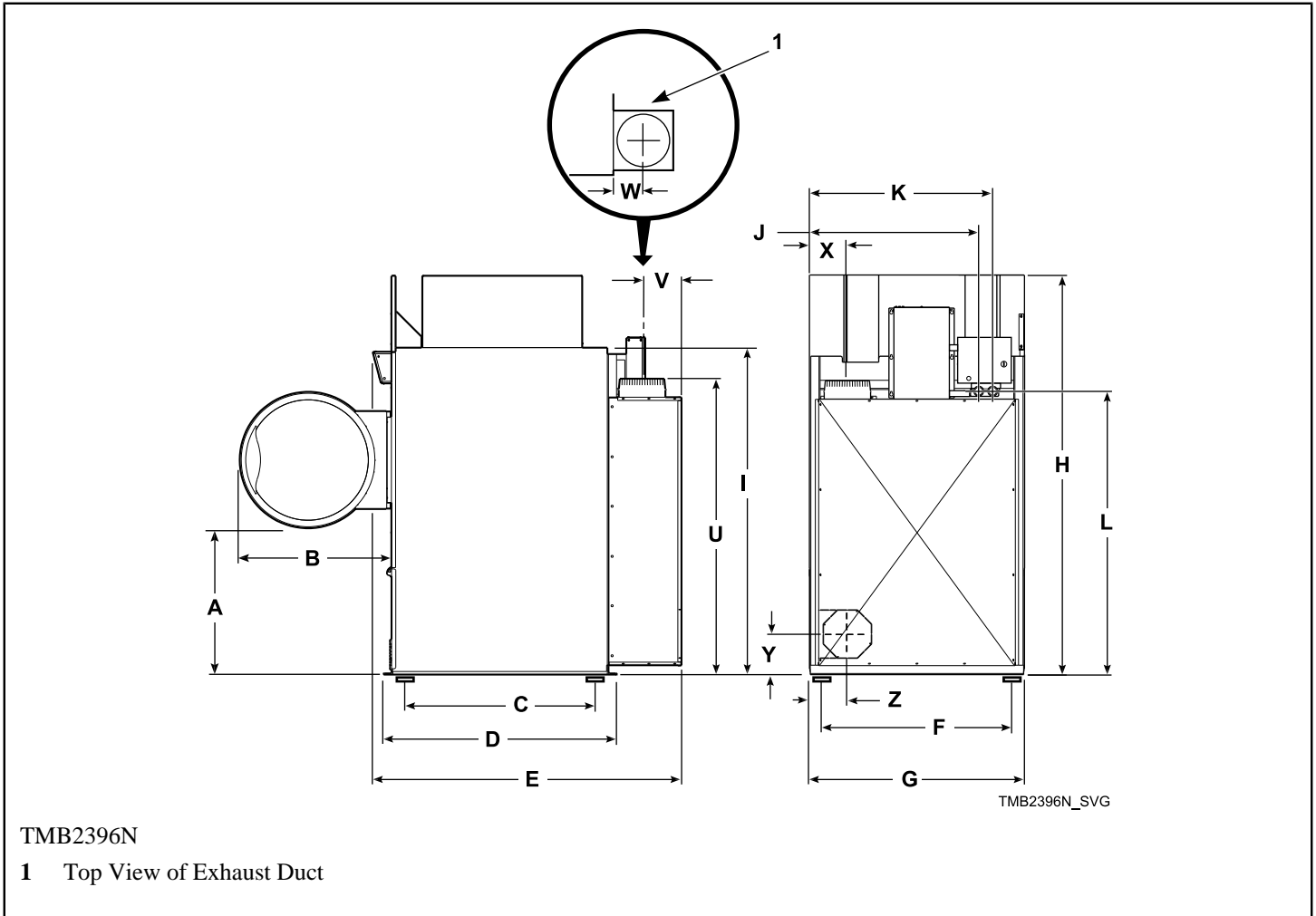

Cabinet Dimensions						
Models	A	B	C	D	E	F
120L/N/E	31.38 in. (797 mm)	32.5 in. (826 mm)	48.91 in. (1,242 mm)	49.91 in. (1,268 mm)	67.92 in. (1,725 mm)	45.38 in. (1,153 mm)
120S	31.38 in. (797 mm)	32.5 in. (826 mm)	48.91 in. (1,242 mm)	49.91 in. (1,268 mm)	67.92 in. (1,725 mm)	45.38 in. (1,153 mm)
Models	G	H	I	J*	K*	L*
120L/N/E	46.38 in. (1,178 mm)	85.7 in. (2,177 mm)	70 in. (1,778 mm)	41.6 in. (1,057 mm)	43.2 in. (1,097 mm)	61.5 in. (1,562 mm)

Cabinet Dimensions						
120S	46.38 in. (1,178 mm)	83.5 in. (2,121 mm)	70 in. (1,778 mm)	41.6 in. (1,057 mm)	43.2 in. (1,097 mm)	61.5 in. (1,562 mm)

* Fire suppression system optional - may not be on machine.

Refer to Position and Level the Tumble Dryer to temporarily reduce the heights of these models.

Exhaust Outlet Dimensions and Locations						
Models	U	V	W	X	Y	Z
120L/N/E	63.45 in. (1,612 mm)	8.44 in. (214 mm)	5 in. (127 mm)	8.18 in. (208 mm)	6.82 in. (173 mm)	8.18 in. (208 mm)
120S	60.7 in. (1,542 mm)	8.44 in. (214 mm)	5 in. (127 mm)	8.18 in. (208 mm)	6.82 in. (173 mm)	8.18 in. (208 mm)

170 and 200 Series Tumble Dryer Dimensions and Exhaust Outlet Locations

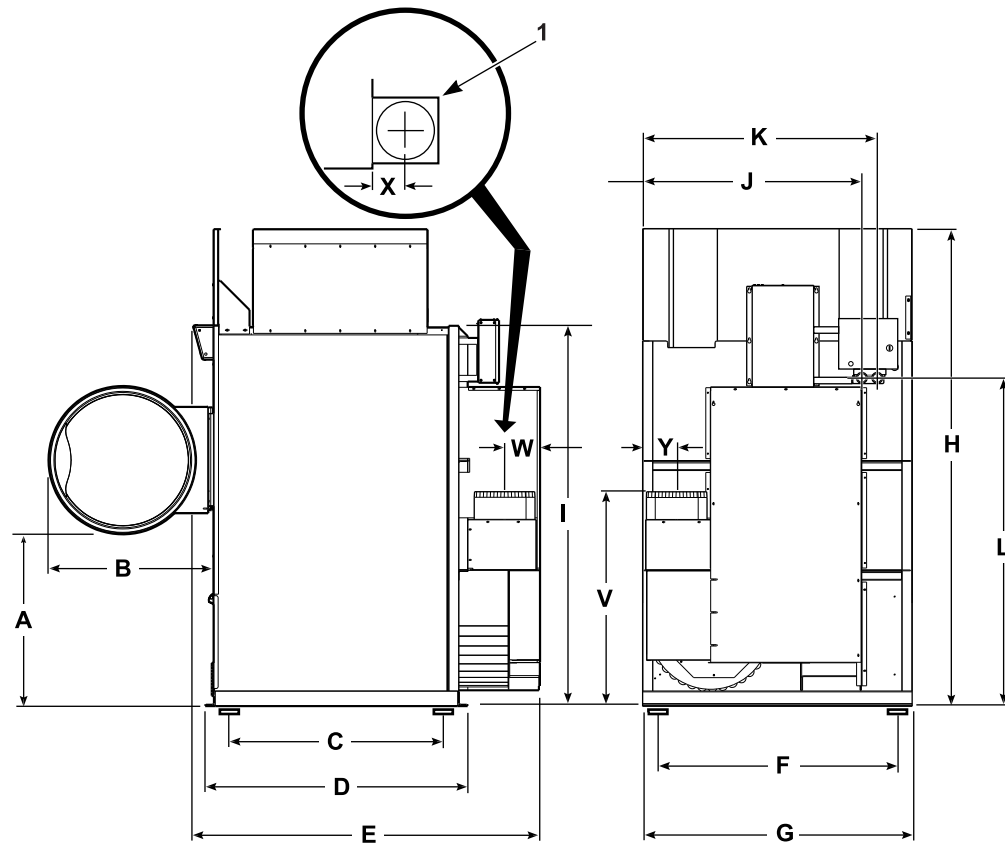

TMB2397N_SVG

TMB2397N

1 Top View of Exhaust Duct

Cabinet Dimensions

Models	A	B	C	D	E	F
170L/N/S	33.86 in. (860 mm)	32.5 in. (826 mm)	50.75 in. (1,289 mm)	51.75 in. (1,314 mm)	68.85 in. (1,749 mm)	52.12 in. (1,324 mm)
200L/N/S	32.1 in. (815 mm)	35.6 in. (904 mm)	58 in. (1,473 mm)	59.25 in. (1,505 mm)	76.35 in. (1,939 mm)	52.12 in. (1,324 mm)

Models	G	H	I	J*	K*	L*
170L/N/S	53.12 in. (1,349 mm)	94 in. (2,388 mm)	75.12 in. (1,908 mm)	48.86 in. (1,241 mm)	50.45 in. (1,281 mm)	62.5 in. (1,588 mm)

Cabinet Dimensions						
200L/N/S	53.12 in. (1,349 mm)	94 in. (2,388 mm)	75.12 in. (1,908 mm)	48.86 in. (1,241 mm)	50.45 in. (1,281 mm)	62.5 in. (1,588 mm)

* Fire suppression system optional - may not be on machine.

Refer to Position and Level the Tumble Dryer to temporarily reduce the heights of these models.

Exhaust Outlet Dimensions and Locations				
Models	V	W	X	Y
170L/N/S	42.38 in. (1,076 mm)	6.75 in. (171 mm)	6 in. (152 mm)	7 in. (178 mm)
200L/N/S	42.38 in. (1076 mm)	6.75 in. (171 mm)	6 in. (152 mm)	7 in. (178 mm)

Electric and Gas Connection Locations for Gas Models Through 3/10/13

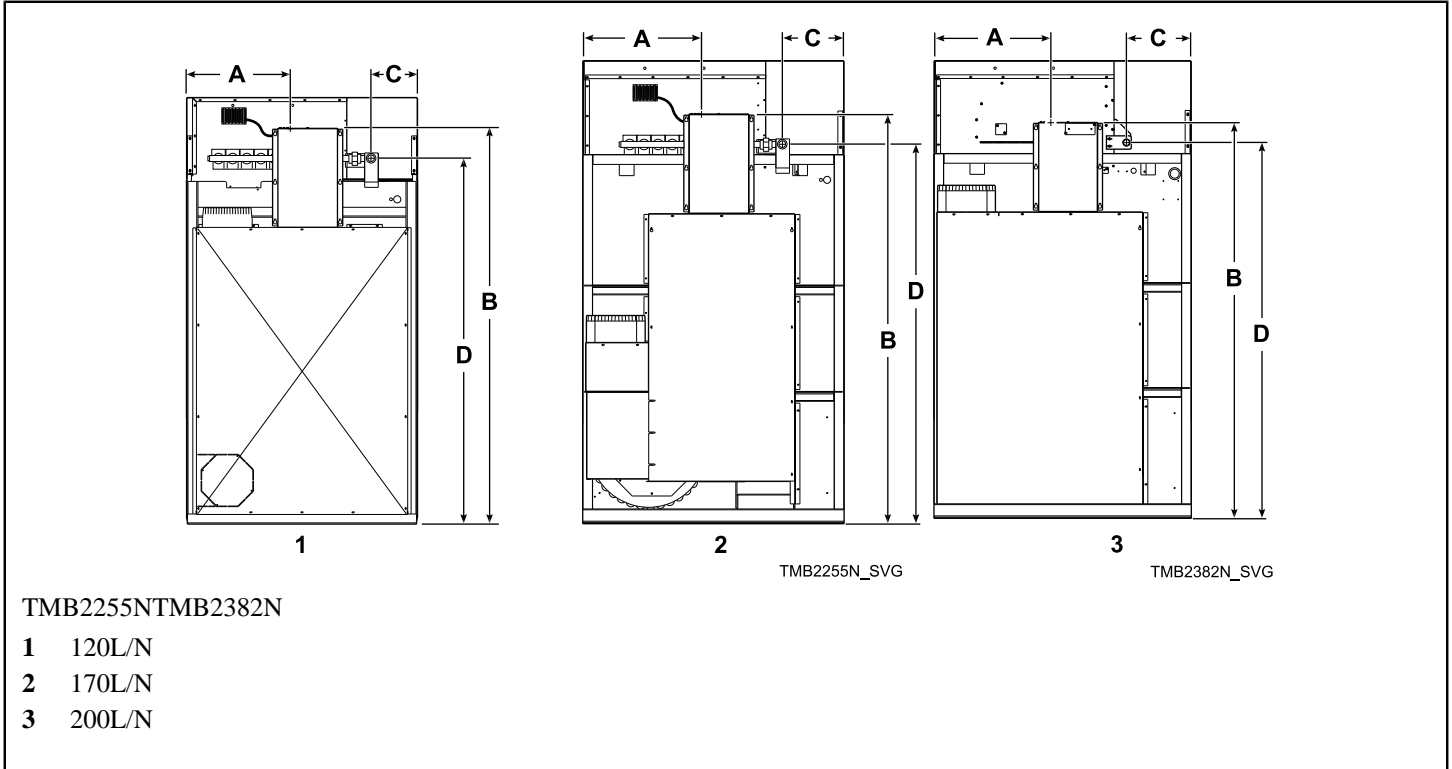

Models	Electrical Connection		Gas Connection		
	A	B	C	D	Diameter
120L/N	18.34 in. (466 mm)	77.84 in. (1,977 mm)	12.5 in. (318 mm)	70.5 in. (1,791 mm)	3/4 in. NPT
170L/N	21 in. (533 mm)	81 in. (2,057 mm)	14.85 in. (377 mm)	77.4 in. (1,966 mm)	1 in. NPT
200L/N	21 in. (533 mm)	81 in. (2,057 mm)	13.7 in. (348 mm)	77.4 in. (1,966 mm)	1 in. NPT

Electric and Gas Connection Locations for Gas Models Starting 3/11/13

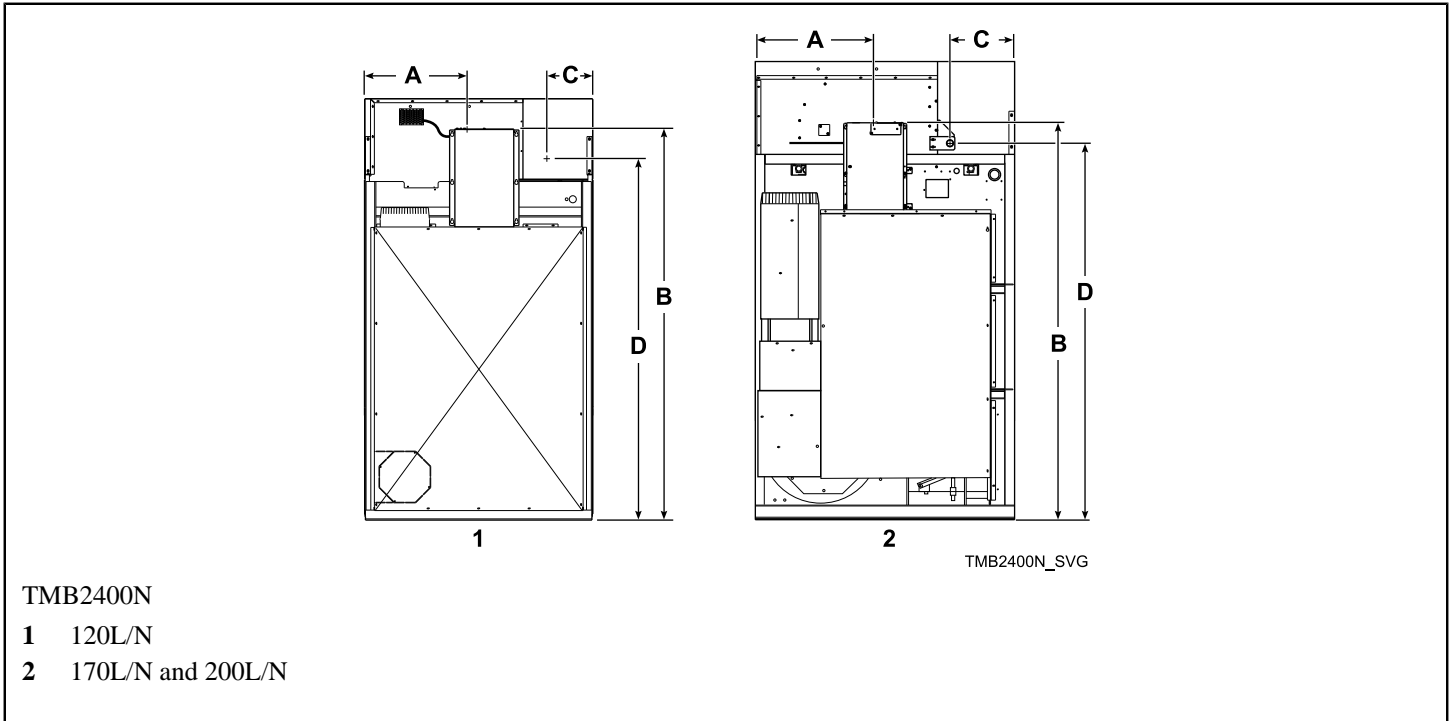

Models	Electrical Connection		Gas Connection		
	A	B	C	D	Diameter
120L/N	18.34 in. (466 mm)	77.84 in. (1,977 mm)	12.5 in. (318 mm)	70.5 in. (1,791 mm)	1 in. NPT
170L/N	21 in. (533 mm)	81 in. (2,057 mm)	14.85 in. (377 mm)	77.4 in. (1,966 mm)	1 in. NPT
200L/N	21 in. (533 mm)	81 in. (2,057 mm)	14.85 in. (377 mm)	77.4 in. (1,966 mm)	1 in. NPT

Electric and Steam Connection Locations for Steam Models Through 3/10/13

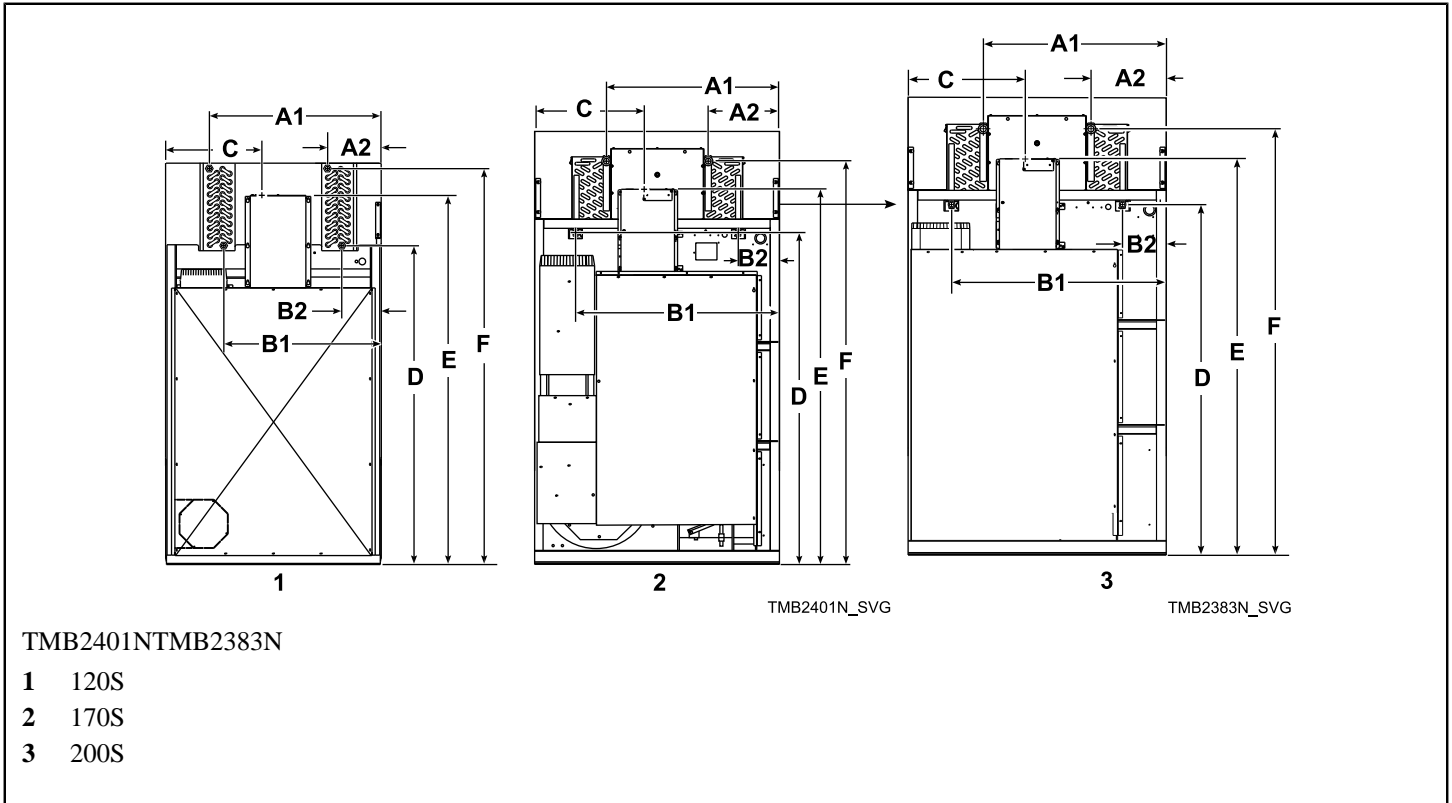

Models	Steam Inlet			
	Diameter	A1	A2	F
120S	3/4 in. NPT	35.875 in. (911 mm)	13.375 in. (340 mm)	82.75 in. (2,102 mm)
170S	3/4 in. NPT	37.625 in. (956 mm)	15.25 in. (387 mm)	88 in. (2,235 mm)
200S	3/4 in. NPT	37.625 in. (956 mm)	15.25 in. (387 mm)	88 in. (2,235 mm)

Models	Steam Outlet			
	Diameter	B1	B2	D
120S	3/4 in. NPT	34.625 in. (879 mm)	13.125 in. (333 mm)	68.5 in. (1,740 mm)
170S	1 in. NPT	44.625 in. (1,133 mm)	8.75 in. (222 mm)	71.75 in. (1,822 mm)

Models	Steam Outlet			
	Diameter	B1	B2	D
200S	1 in. NPT	44.625 in. (1,133 mm)	8.75 in. (222 mm)	71.75 in. (1,822 mm)

Models	Electrical Connection	
	C	E
120S	18.34 in. (466 mm)	77.84 in. (1,977 mm)
170S	21 in. (533 mm)	81 in. (2,057 mm)
200S	21 in. (533 mm)	81 in. (2,057 mm)

Electric and Steam Connection Locations for Steam Models Starting 3/11/13

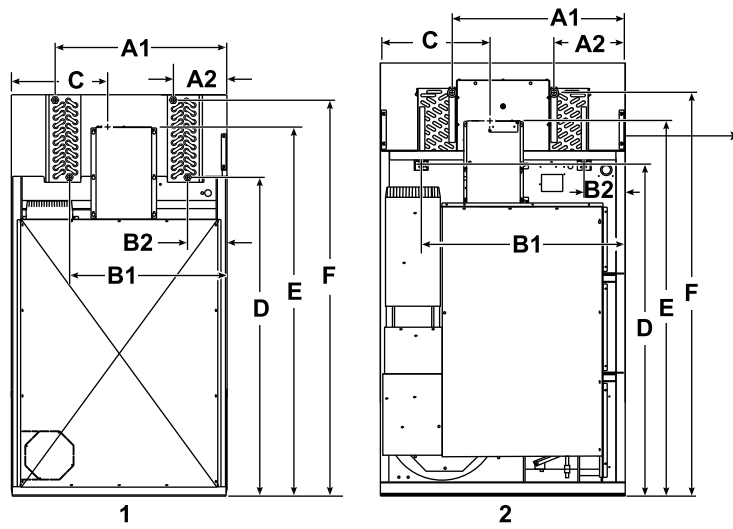

TMB2401N_SVG

TMB2401N

1 120S

2 170S and 200S

Models	Steam Inlet			
	Diameter	A1	A2	F
120S	3/4 in. NPT	35.875 in. (911 mm)	13.375 in. (340 mm)	82.75 in. (2,102 mm)
170S	3/4 in. NPT	37.625 in. (956 mm)	15.5 in. (394 mm)	87.625 in. (2,226 mm)
200S	3/4 in. NPT	37.625 in. (956 mm)	15.5 in. (394 mm)	87.625 in. (2,226 mm)

Models	Steam Outlet			
	Diameter	B1	B2	D
120S	3/4 in. NPT	34.625 in. (879 mm)	13.125 in. (333 mm)	68.5 in. (1,740 mm)
170S	1 in. NPT	44.125 in. (1,133 mm)	9 in. (229 mm)	72.125 in. (1,832 mm)

Models	Steam Outlet			
	Diameter	B1	B2	D
200S	1 in. NPT	44.125 in. (1,133 mm)	9 in. (229 mm)	72.125 in. (1,832 mm)

Models	Electrical Connection	
	C	E
120S	18.34 in. (466 mm)	77.84 in. (1,977 mm)
170S	21 in. (533 mm)	81 in. (2,057 mm)
200S	21 in. (533 mm)	81 in. (2,057 mm)

Electric Connection Location for Electric Models

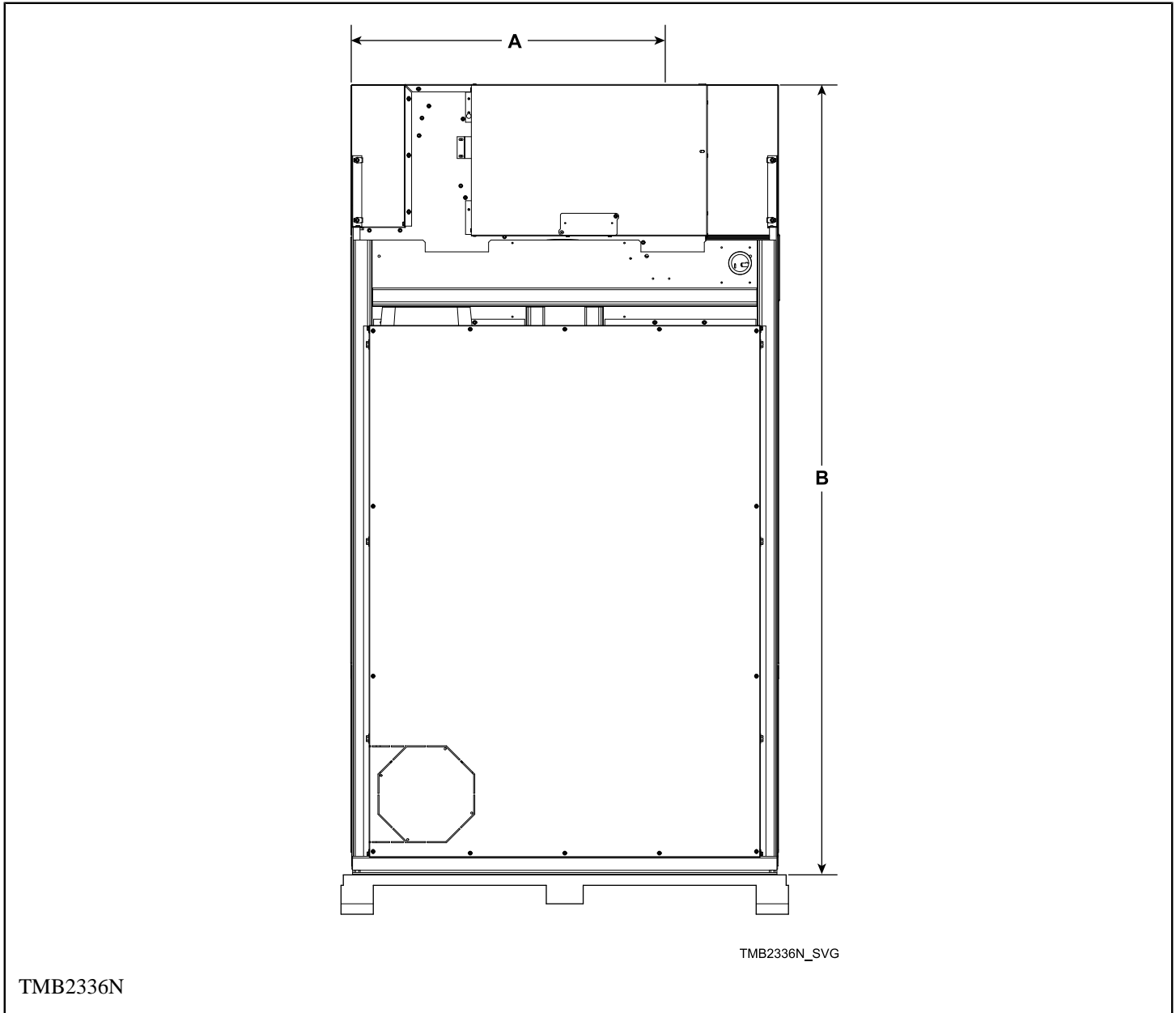

Models	A	B
120E	35.81 in. (910 mm)	85.64 in. (2,175 mm)

Installation

Pre-Installation Inspection

Upon delivery, visually inspect the crate, carton and parts for any visible shipping damage. If the crate, carton, or cover is damaged or signs of possible damage are evident, have the carrier note the condition on the shipping papers before the shipping receipt is signed, or advise the carrier of the condition as soon as it is discovered.

Remove the crate and protective cover as soon as possible and check the items listed on the packing list. Advise the carrier of any damaged or missing articles as soon as possible. A written claim should be filed with the carrier immediately if articles are damaged or missing.

IMPORTANT: Remove the shipping tape from the two back draft dampers located in the exhaust outlet.

IMPORTANT: Warranty is void unless tumble dryer is installed according to instructions in this manual. Installation should comply with minimum specifications and requirements detailed in this manual and applicable local gas fitting regulations, municipal building codes, water supply regulations, electrical wiring regulations, and any other relevant statutory regulations. Due to varied requirements, applicable local codes should be thoroughly understood and all pre-installation work arranged for accordingly.

Materials Required (Obtain Locally)	
All Models	One Single Pole fused disconnect switch or circuit breaker on 1 Phase models. Circuit breaker on 3 Phase models.
Gas Models	One gas shut-off valve for gas service line to each tumble dryer.

Materials Required (Obtain Locally)	
Steam Models	One steam shut-off valve for steam service line to be connected upstream of solenoid steam valve. Two steam shut-off valves for each condensate return line. Flexible steam hoses with a 125 psig (pounds per square inch gauge) (8.79 kg/sq. cm) working pressure for connecting steam coils. Refer to <i>Figure 21 120 Series Tumble Dryers</i> and <i>Figure 22 170 and 200 Series Tumble Dryers</i> for sizing and connection configurations. Two steam traps for steam coil outlets to condensate return line. Optional – Two vacuum breakers for condensate return lines.

IMPORTANT: 3 Phase Only – Each tumble dryer must be connected to its own individual branch circuit breaker, not fuses, to avoid the possibility of “single phasing” and causing premature failure of the motor(s).

Location Requirements

The tumble dryer must be installed on a level floor. Floor covering materials such as carpeting or tile should be removed.

To assure compliance, consult local building code requirements. The tumble dryer must not be installed or stored in area where it will be exposed to water and/or weather.

IMPORTANT: DO NOT block the airflow at the rear of the tumble dryer with laundry or other articles. Doing so would prevent adequate air supply to the combustion chamber of the tumble dryer.

A typical tumble dryer enclosure is shown in *Figure 2*.

IMPORTANT: Install tumble dryers with sufficient clearance for servicing and operation, refer to *Figure 2*.



WARNING

To reduce the risk of severe injury, clearance of tumbler cabinet from combustible construction must conform to the minimum clearances, and/or local codes and ordinances.

W770

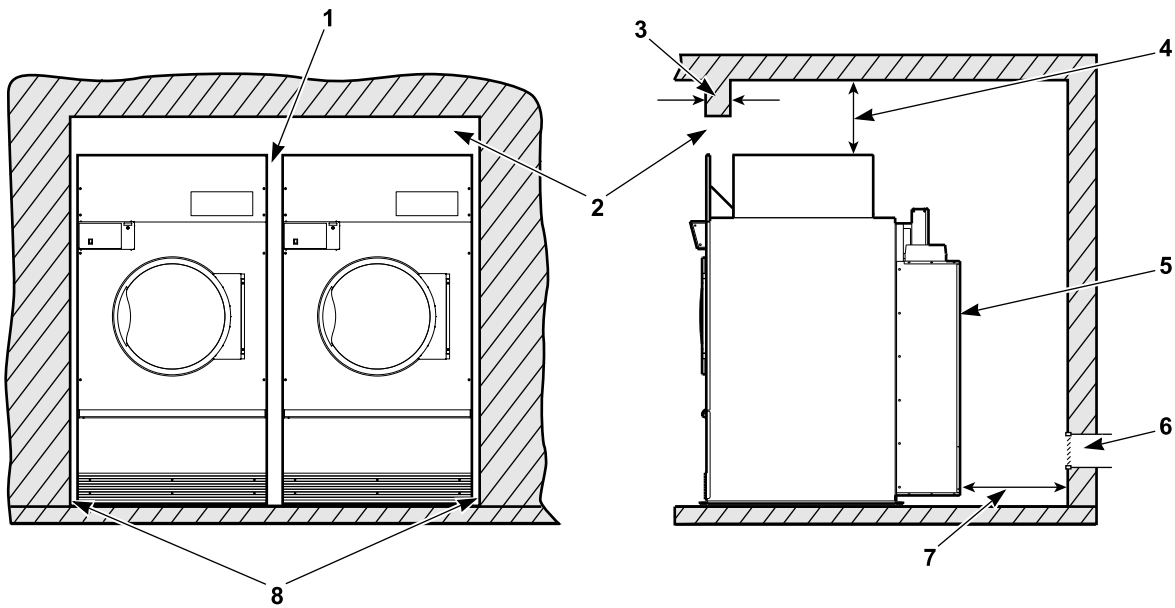

TMB2020N_SVG

NOTE: Shaded areas indicate adjacent structure.

- 1 0.5 in. (13 mm) recommended between machines for removal or installation
- 2 Allow 2-4 in. (51-102 mm) opening at top of machine to aid in removal or installation. A removable trim piece may be used to conceal the opening; zero clearance allowed for trim.
- 3 4 in. (102 mm) maximum header thickness
- 4 Minimum clearance permitted for remainder:

120 Gas/Electric	4 in. (101.6 mm)
120 Steam	6 in. (152.4 mm)
170/200 Gas	4 in. (101.6 mm)
170/200 Steam	8 in. (203.2 mm)

- 5 Guard
- 6 Provision for make-up air
- 7 24 in. (610 mm) minimum, 36 in. (914 mm) recommended for maintenance purposes
- 8 0.25 in. (6 mm) recommended for removal or installation purposes, zero clearance allowed

Figure 2

Position and Level the Tumble Dryer

The tumble dryer may be moved with or without the skid. To remove the skid, unscrew the four shipping bolts, and discard them.

To fit a 170 and 200 series tumble dryer (with shipping skid) through a 8 foot (2.43 meters) high door, you must remove the front access panel. The upper 3 inches (76 mm) of the stove must also be removed on 170 series gas tumble dryers. Removing the entire gas or steam heater assembly and the shipping skid, will reduce the height of the 120 series tumble dryer to 70 inches (1,778 mm), and the 170 and 200 series tumble dryer to 75 inches (1,905 mm).

Level the tumble dryer to within 0.125 inch (3 mm) from front-to-rear (level on cylinder rib), and side-to-side (level on top panel). Shim under corners to level and stabilize unit. Tumble dryer must not rock.

Fire Suppression System (Optional Equipment)

	WARNING
<p>Electrical shock can result in death or serious injury. If the water dispensing system is activated, do not attempt to operate the tumble dryer. If the water dispensing system is activated, have the tumble dryer inspected by a qualified agency before operating the tumble dryer.</p>	
W879	

Check Local Codes and Permits

Call your local water company or the proper municipal authority for information regarding local codes.

IMPORTANT: It is your responsibility to have ALL plumbing connections made by a qualified professional to assure that the plumbing is adequate and conforms to local, state, and federal regulations or codes.

IMPORTANT: It is the installation or owner's responsibility to see that the necessary or required water, water pressure, pipe size, or connections are provided. Manufacturer assumes no responsibility if the fire suppression system is not connected, installed, or maintained properly.

Water Requirements

IMPORTANT: Water must be supplied to the fire suppression system, or the fire suppression system will not operate as intended.

Connection point to the electric water solenoid valve is a 3/4 inch (19 mm) hose. The fire suppression system equipped tumble dryer must be supplied with a minimum water pipe size of 1/2 inch (12.7 mm) and be provided with a minimum of 20 psi (138 kPa) and a maximum of 120 psi (827 kPa) of pressure at all times. Flowrate must be no less than, but approximately 15 gallons (57 liters) per minute.

NOTE: Water pressure under 20 psi (138 kPa) will cause low flow and water leakage at water solenoid valve.

If the rear of the tumble dryer or the water supply is located in an area where it will be exposed to cold/freezing temperatures, provisions must be made to protect these water lines from freezing.

IMPORTANT: Temperature of the water supply must be kept between 40°F and 120°F (4.4°C and 48.9°C) . If water in the supply line or water solenoid valve freezes, the fire suppression system will not operate.

IMPORTANT: If temperature sensors inside the tumble dryer register a temperature below 40F° (4.4°C) , the fire suppression system control will lock out. This feature protects against operation of the tumble dryer with a possible frozen water supply. Only when the temperature sensors register a temperature above 40F° (4.4°C) will the machine reset for operation.

IMPORTANT: Flexible supply line/coupling must be used. Solenoid valve failure due to hard plumbing connections will void the warranty. It is recommended that a filter or strainer be installed in the water supply line.

Water Connections

Two hoses and a Y-valve are provided with the tumble dryer to allow for connection of water supply to tumble dryer. The water connections are made to the bushings of the water solenoid valve, located on the rear of the tumble dryer. The Y-valve provides a single female hose connection (Standard US 3/4-11 1/2 NH thread). Refer to *Figure 3* and *Figure 4* .

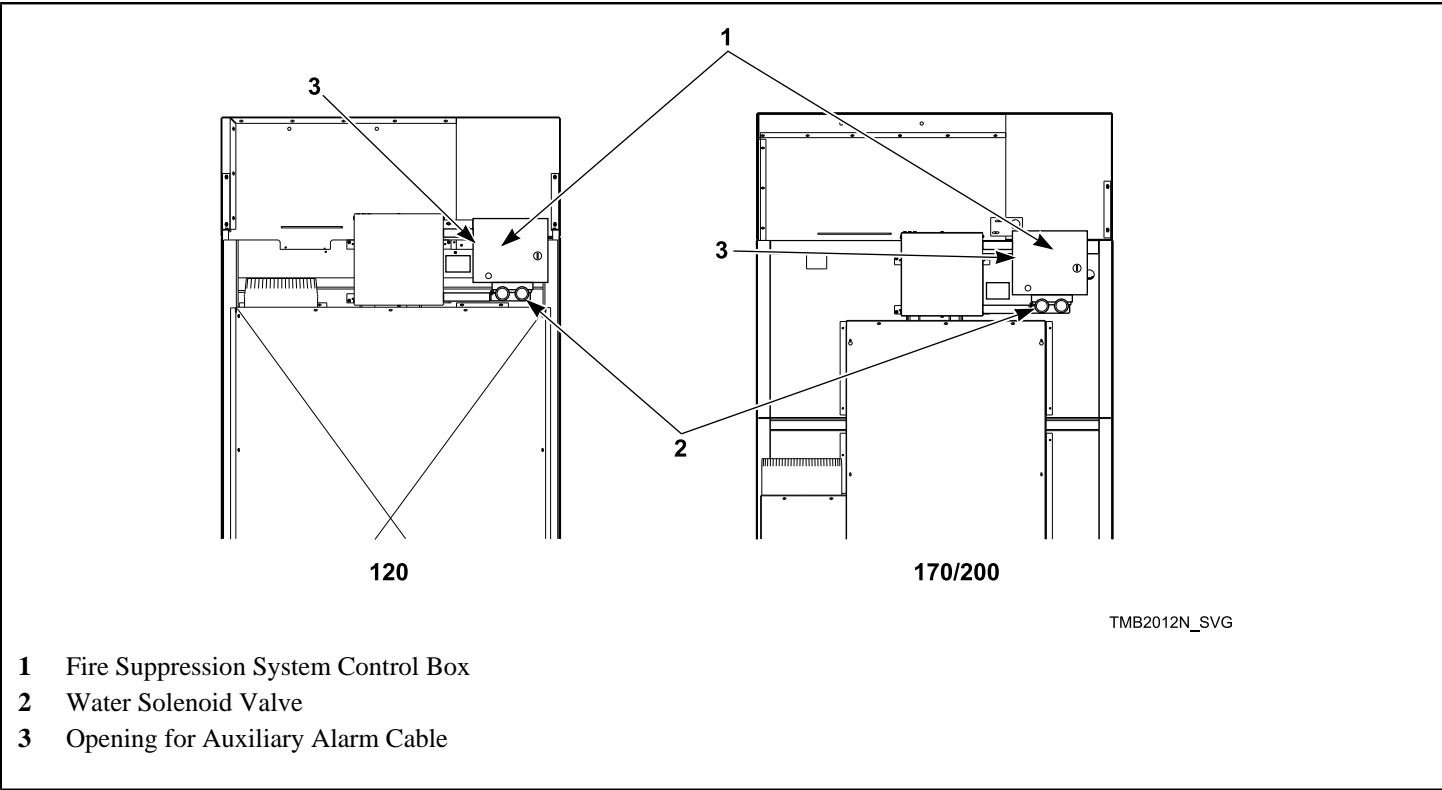

Figure 3

To connect the two hoses (supplied with tumble dryer), insert rubber washers (from literature pack) in water inlet hose couplings. Refer to *Figure 4*.

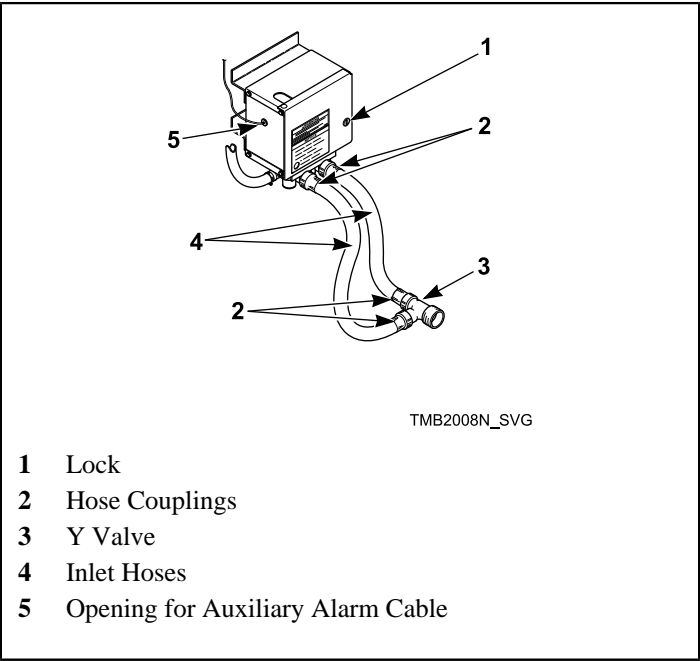

Figure 4

Connect inlet hoses to water supply. Flush the lines for approximately two minutes to remove any foreign materials

that could clog the screens in the water mixing valve. This is especially important when installing a tumble dryer in a newly constructed or renovated building. Then connect the hoses to the Y-valve; connect the Y-valve to the connections at the rear of the tumble dryer.

IMPORTANT: Thread hose couplings onto valve connections finger tight, then turn 1/4 turn with pliers. Do not cross thread or overtighten couplings.

IMPORTANT: Hoses and other natural rubber parts deteriorate after extended use. Hoses may develop cracks, blisters or material wear from the temperature and constant high pressure they are subjected to. All hoses should be checked on a yearly basis for any visible signs of deterioration. Any hose showing the signs of deterioration listed above should be replaced immediately. All hoses should be replaced every five years.

NOTE: Longer inlet hoses are available (as optional equipment at extra cost) if the hoses supplied with the tumble dryer are not long enough for installation. Order hoses as follows:

Part No. 20617 Inlet hose 8 feet (2.44 m)

Part No. 20618 Inlet hose 10 feet (3.05 m)

NOTE: Replacement outlet hoses are available (at extra cost). Order 44073302 Hose, 21 in. (53 cm)21 in. for 120 series and 44073303, 31 in. (79 cm) for 170 and 200 series.

Electrical Requirements

	<h2 style="margin: 0;">WARNING</h2>
<p>Electrical power must be provided to tumbler at all times. The fire suppression system will be inoperative if the main electrical power supply is disconnected.</p>	
<p>W690</p>	

No independent external power source or supply connection is necessary. Power to operate the 24 Volt fire suppression system is from the rear junction/contactor box.

Auxiliary Alarm

The fire suppression system provides an auxiliary output signal when the system is activated. During tumble dryer installation, you have the option to connect a separate alarm system to this auxiliary output. Potential uses of the auxiliary output include, but are not limited to: (1) sounds an alarm, (2) activates a building sprinkler system, (3) notifies a fire department, etc. Use of the auxiliary output is not required for the fire suppression system to operate, but may be used for additional protection.

The connection to the auxiliary output is made through the FS-1 and FS-2 fast-on connections inside the fire suppression control box. Refer to *Figure 5* . The relay is rated for 24 VAC, 5.2 Amp, sealed current.

NOTE: The auxiliary output is activated during fire suppression system maintenance test sequence. Consider this fact prior to your system test every three months. (Example: If the external system uses the auxiliary output to call the fire department, inform the fire department before and after the fire suppression system maintenance test.)

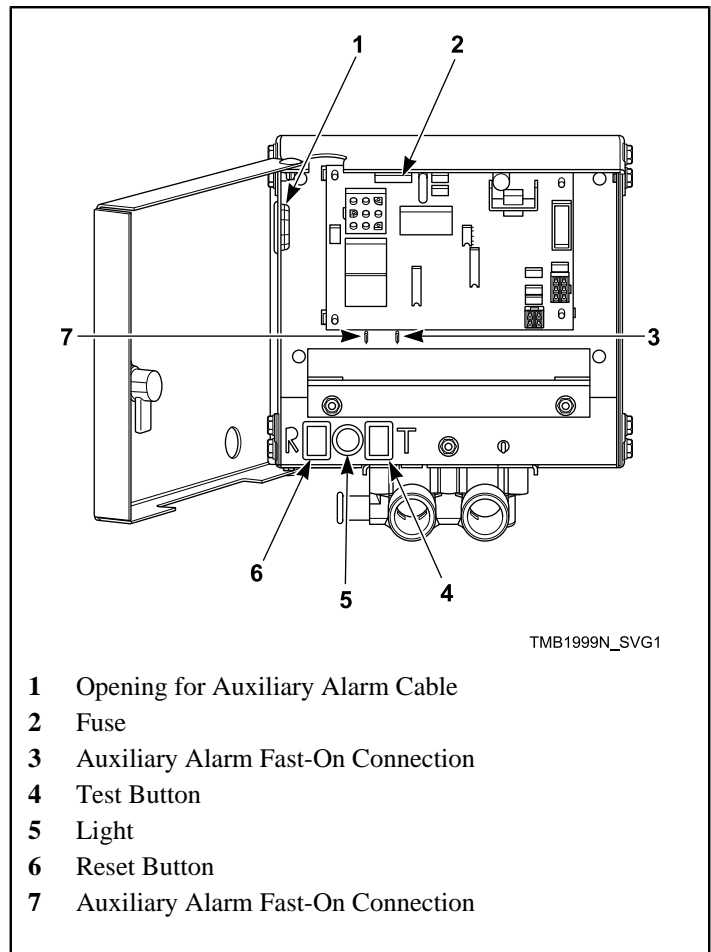

Figure 5

Before Placing Tumble Dryer into Service

1. Remove or open all panels and check accessible bolts, nuts, screws, terminals and fittings for tightness.
2. Check belt tension and adjust if necessary. Refer to Adjustments section.
3. Replace all panels and guards.
4. Turn on electrical supply to tumble dryer.
5. Open the supply valve for gas or steam heated tumble dryers.
6. After performing the previous checks, start the tumble dryer by pressing START. (Refer to the Operating section for detailed instructions.) Release the start button and open the loading door. The cylinder should stop rotating within seven seconds after the door is opened a maximum of 2 inches (51 mm) . If it does not, adjust the loading door switch. Refer to Adjustments section.
7. **Gas Tumble Dryers:** Start the tumble dryer and check the burner flame. Adjust the air inlet shutter as required. Refer to Adjustments section.

IMPORTANT: The electronic ignition system will attempt to light the gas by sparking for the “trial for ignition” period. If gas does not ignite within this period, the ignition control will go into a safety lockout and the valve will no longer open until the control is reset. It may be necessary to retry several times to bleed air from the gas lines. To reset, open and close the loading door and restart tumble dryer.

IMPORTANT: If lockout condition persists, check that the manual gas shut-off valve is in the ON position and that the gas service is properly connected. If condition still persists, remove tumble dryer from service.

8. Load the cylinder with a full load of clean rags and run to remove oil or dirt from cylinder.
9. Check the airflow switch operation by opening the lint panel; be sure to remove shipping tape from airflow switch prior to operation. Temporarily tape down the lint panel safety switch located behind the upper left corner of the lint panel. The heating systems should shut off when the lint panel is opened a maximum of 6 inches (152.4 mm).

The airflow switch operation may be affected by shipping tape still in place, lack of make-up air, or an obstruction in the exhaust duct. These should be checked. If there is a problem, contact an authorized service person.

	WARNING
<p>Do not operate tumble dryer if airflow switch is faulty. An explosive gas mixture could collect in tumble dryer if airflow switch does not operate properly.</p>	
W407R1	

10. Wipe out the cylinder using an all-purpose cleaner or detergent and water solution. Refer to *Figure 6*.

IMPORTANT: The use of chlorine bleach for removing any discoloration should be avoided because bleach could damage the finish.

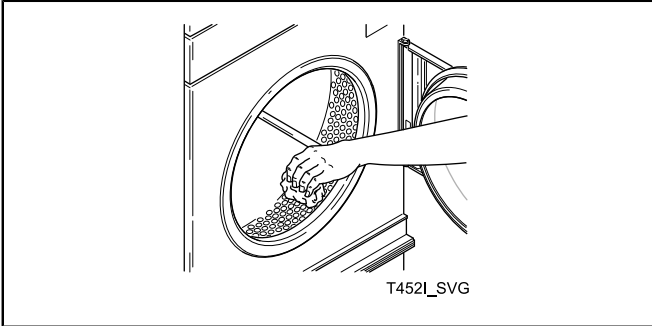

Figure 6

Models		Prepurge Time (seconds)	Trial for Ignition (seconds)	Reset Lockout Condition By:
Models through 3/10/13	CE and Australia	18	10	025, 030, 035, 055: Press reset button on rear of machine T30, T45: Press lighted reset button in rear contactor box
	All others	1-3	10	Open loading door
Models starting 3/11/13 through 12/31/13	CE	1	10 (attempts to ignite 3 times)	For models with EO, RE, RU or UO control suffixes: Press start on control keypad. For models with all other control suffixes: Press and hold reset button on junction box until light goes out.

Models		Prepurge Time (seconds)	Trial for Ignition (seconds)	Reset Lockout Condition By:
Models Starting 3/11/13	Non-CE and non-Australian	1	10 (attempts to ignite 3 times)	Open loading door
Models starting 3/11/13 through 7/31/13	Australia	18	10	025, 030, 035, 055: Press reset button on rear of machine T30, T45: Press lighted reset button in rear contactor box
Models starting 8/1/13	Australia	23	23	For models with EO, RE, RU or UO control suffixes: Press start on control keypad. For models with all other control suffixes: Press and hold ignition control reset button.
Models Starting 1/1/14	CE			

If the tumble dryer does not meet ANY of the listed requirements, remove tumble dryer from use. Refer to Removing Tumble Dryer from Service section.

Required for CE Models Only

Once machine is installed, please be sure to complete the following items:

- Review and verify machine operation with customer.
- Leave all literature and a signed Declaration of Conformity with customer.
- Review machine warranty information with customer.
- Apply warning sticker on front panel of machine, in language appropriate to country of sale (included in literature packet).

Installing CE Gas Drying Tumble Dryer

General Information

This information is to be used when installing gas tumble dryers in countries and/or on gases different than the machine's factory configuration. Tumble Dryers are supplied from the factory for operation on Natural Gas 1000 Btu/cu. ft. (8914 kcal/m³), or L.P. Gas 2500 Btu/cu. ft. (22,250 kcal/m³), with natural gas group H/E, designation G20 and L.P. gas group B/P, designation G30. To install machines in any other country, or on any other gas, requires some level of modification.

Machines are built in two different configurations:

- Natural Gas – regulated/governor
- Liquefied Petroleum (L.P.) Gas – not regulated/no governor

Serial plates supplied from the factory are configured for GB/IE/PT/ES/IT/GR/LU/CH/BE. These instructions pertain to the situations when the country of use or gas supply is different than that on the serial plate. If applicable, peel off the appropriate country sticker (included with machine) and apply it to the serial plate over the existing country information.

These instructions are only valid if the following country code is on the appliance: GB/IE/PT/ES/IT/GR/LU/CH/BE. If this code is not present on the appliance, it is necessary to refer to the technical instructions which will provide the necessary information concerning the modification of the appliance to the condition of use for the country.

Before installation, check that the local distribution conditions, nature of gas and pressure, and the adjustment of the appliance are compatible.

Table 1 describes the different gases that are available in different CE countries, and how the machines need to be configured to operate with those gases. In the CE, there are Natural Gas configurations that do not allow for machine regulation and L.P. Gas configurations that must be regulated. For L.P. Gas, third family B/P at 50 mbar (5 kPa), order

Regulated Natural Gas machines and convert according to *Table*

1.

CE Orifices

Gas Type	Gas Family	Group	Gas Designation	Supply Pressure in. wc (mbar, kPa)	Manifold Pressure in. wc (mbar, kPa)	Capacity/ Model	Orifice Diameter inch (mm)	Orifice Part Number	Quantity				
Natural Gas	Second	I _{2H(E)}	G20	8/10 (20/25, 2/2.5)	3.57 (8.9, 0.89)	120	0.1695 (4.3)	M402988	3				
						170	0.1850 (4.7)	M411510	4				
						200	0.1890 (4.8)	M411372	4				
						I _{2L}	G25	10 (25, 2.5)	5.06 (12.6, 1.26)	120	0.1695 (4.3)	M411373	3
										170	0.1850 (4.7)	M411510	4
										200	0.1890 (4.8)	M411372	4
		I _{2E+}	G20	8 (20, 2.0)	Unregulated	120	0.1417 (3.6)	M401014	3				
						170	0.1496 (3.8)	M402997	4				
						200	0.1520 (3.9)	M401020	4				
		LP	Third	I _{3B/P}	G30	11.25/12 (28/30, 2.8/3.0)	Unregulated	120	0.0980 (2.5)	M406361	3		
								170	0.1200 (3.0)	M401017	3		
								200	0.1220 (3.1)	70070903	3		

Gas Type	Gas Family	Group	Gas Designation	Supply Pressure in. wc (mbar, kPa)	Manifold Pressure in. wc (mbar, kPa)	Capacity/ Model	Orifice Diameter inch (mm)	Orifice Part Number	Quantity
			G30	14.9/20 (37/50, 3.7/5.0)	12.05 (30, 3.0)	120	0.0980 (2.5)	M406361	3
						170	0.1200 (3.0)	M401017	3
						200	0.1220 (3.1)	70070903	3
		I ₃₊ / 3P	G30 / G31	11.25/14.9 (28/37, 2.8/3.7)	Unregulated	120	0.0980 (2.5)	M406361	3
						170	0.1200 (3.0)	M401017	3
						200	0.1220 (3.1)	70070903	3

Table 1

Properties of CE Gases

Gas Type	Gas Family	Group	Gas Description	Gas Designation	Wi	Hi	Ws	Hs	d
					Wobbe Index (net)	Heating Value (net)	Wobbe Index (gross)	Heating Value (gross)	Density
					Btu/ft ³ (MJ/m ³)	Btu/ft ³ (MJ/m ³)	Btu/ft ³ (MJ/m ³)	Btu/ft ³ (MJ/m ³)	
Natural Gas	Second	I _{2H,E}	Not Applicable	G20	1226 (45.67)	913 (34.02)	1362 (50.72)	1014 (37.78)	0.555
		I _{2E+}	2H						
		I _{2L}	Not Applicable	G25	1004 (37.38)	785 (29.25)	1115 (41.52)	872 (32.49)	0.612
		I _{2E+}	2L						

Gas Type	Gas Family	Group	Gas Description	Gas Designation	Wi	Hi	Ws	Hs	d
					Wobbe Index (net)	Heating Value (net)	Wobbe Index (gross)	Heating Value (gross)	Density
					Btu/ft ³ (MJ/m ³)	Btu/ft ³ (MJ/m ³)	Btu/ft ³ (MJ/m ³)	Btu/ft ³ (MJ/m ³)	
LP	Third	I _{3B/P}	Not Applicable	G30	2164 (80.58)	3117 (116.09)	2345 (87.33)	3378 (125.81)	2.075
		I ₃₊	Pure Butane						
		I ₃₊	Pure Propane	G31	1898 (70.69)	2363 (88)	2063 (76.83)	2568 (95.65)	1.55
		I _{3P}	LPG with Propane						

Table 2

Changing Gas Configuration

- Determine the necessary conversion operations to convert from the factory-supplied configuration to the desired configuration.
- Perform the conversions required so the machine is properly configured for the desired country and gas. Refer to the following sections:
 - How to Convert Gas Valve from Regulated to Unregulated
 - How to Change Burner Orifice Size
 - How to Adjust Gas Valve Governor/Regulator

	WARNING
<p>When converting the tumble dryer to a different gas or pressure, first verify that the supply inlet pressure is equipped with a pressure regulator (located ahead of the tumble dryer) that will maintain the gas supply at the inlet pressure specified.</p>	
W430R1	

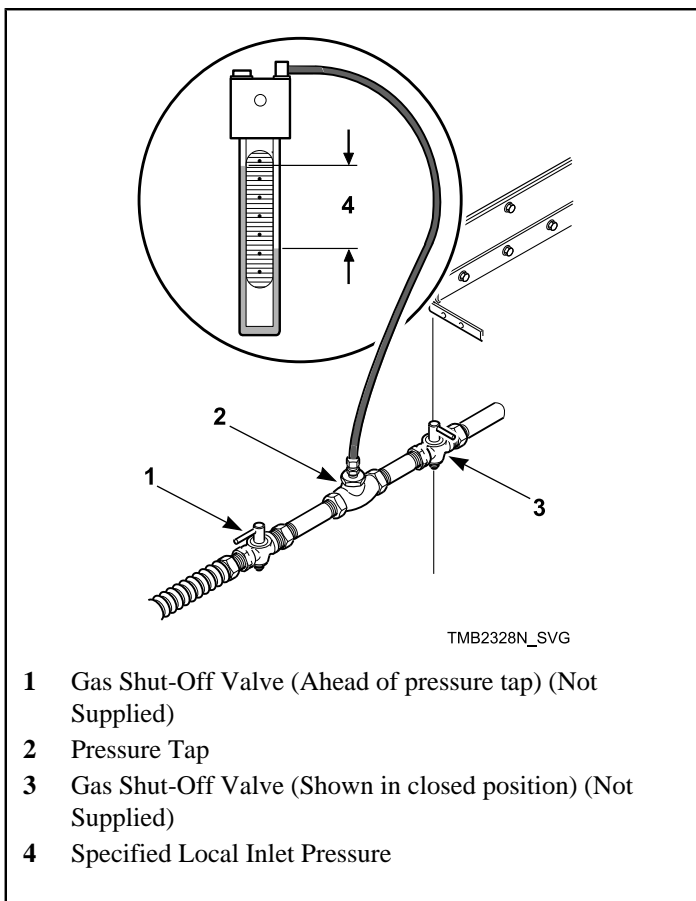

Figure 7

How to Change Burner Orifice Size

1. Disconnect electrical power from tumble dryer. Close gas shut-off valve to tumble dryer. Refer to *Figure 7* .

Specific Conversion Procedures

How to Convert Gas Valve from Regulated to Unregulated

NOTE: Conversion from regulated to unregulated is only needed when regulated tumble dryers were ordered, but unregulated tumble dryers were needed.

1. Disconnect electrical power from tumble dryer. Close gas shut-off valve to tumble dryer. Refer to *Figure 7* .
2. Follow instructions in Conversion Kit.
 Models through 3/10/13 Part No. M400763 (two kits required)
 Models starting 3/11/13 Part No. 44240401P

NOTE: These kits do not contain any burner orifices.

3. Replace burner orifice(s) as per *Table 1* .
4. If applicable, peel off the appropriate conversion sticker (included with machine) and apply it to the serial plate over the “ADJUSTED FOR _____ GAS: _____” information.
5. Commission tumble dryer for use.

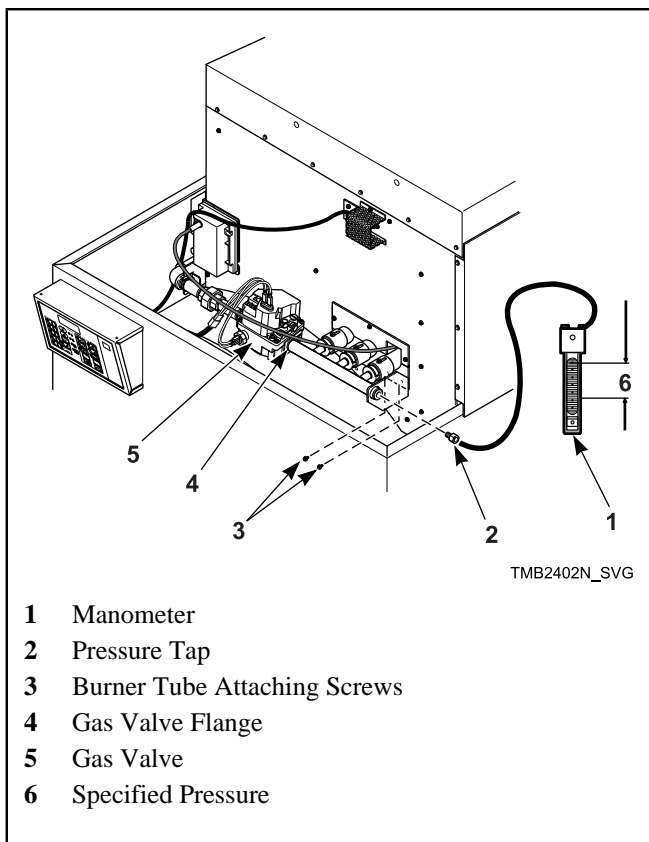

Figure 8

burner orifice pressure per applicable table is achieved. Replace regulator cap. Refer to *Figure 8*.

5. Commission tumble dryer for use.

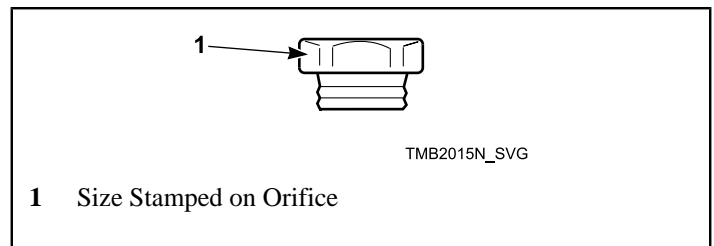

Figure 9 Burner Orifice

2. Remove gas valve:
 - a. Remove the burner orifice(s) from the spud holder.
 - b. When converting from Natural Gas to L.P. Gas, the left-most burner and orifice (viewed from front) must be removed.
 - c. In place of the removed orifice, a blank orifice (Part No. M400995) and a Burner Opening Cover (Part No. M413099) must be installed.
3. Install the new, correct burner orifice(s). Refer to *Figure 9 Burner Orifice* and *Table 1*. Torque each to 9 – 10 Nm.
4. Reinstall spud holder assembly to gas valve, making certain burner orifice(s) are in line with burner tube opening. Refer to *Figure 9 Burner Orifice*.
5. Commission tumble dryer for use.

NOTE: Blank burner orifices are Part No. M400995.

How to Adjust Gas Valve Governor/Regulator

1. Check gas burner orifice (manifold) pressure as follows. Refer to *Figure 8*.
2. Remove screw plug from pressure tap.
3. Connect a “U”-tube manometer (or similar pressure gauge) to the burner orifice (manifold) pressure tap.
4. Start tumble dryer and note pressure once flame is burning. Remove regulator cap and adjust regulator screw until the

Exhaust Requirements

Exhaust Requirements

	WARNING
<p>A drying tumble dryer produces combustible lint. To reduce the risk of fire, the tumble dryer must be exhausted to the outdoors.</p>	
W057R1	

	WARNING
<p>To reduce the risk of fire, DO NOT use plastic or thin foil ducting to exhaust the tumbler.</p>	
W773	

	WARNING
<p>To reduce the risk of fire and accumulation of combustible gases, DO NOT exhaust tumble dryer air into a window well, gas vent, chimney or enclosed, unventilated area such as an attic wall, ceiling, crawl space under a building, or concealed space of a building.</p>	
W059R1	

Layout

Whenever possible, install tumble dryers along an outside wall where duct length can be kept to a minimum, and make-up air can be easily accessed. Construction must not block the airflow at the rear of the tumble dryer. Doing so would prevent adequate air supply to the tumble dryer combustion chamber.

Make-Up Air

A tumble dryer is forced air exhausted and requires provisions for make-up air to replace air exhausted by tumble dryer.

IMPORTANT: Do not obstruct flow of combustion and ventilation air.

Required Make-Up Air Opening (to the outside) for Each Tumble Dryer	
Model	Opening
120 Series	360 in. ² (232,258 mm ²)
170 Series	525 in. ² (338,709 mm ²)
200 Series	525 in. ² (338,709 mm ²)

Make-up air openings with louvers will restrict airflow. The opening must be increased to compensate for area taken up by louvers.

Make-up air openings in rooms containing tumble dryer(s) and/or gas fired hot water heater or other gravity vented appliances must be increased sufficiently to prevent downdrafts in any of the vents when all tumble dryers are in operation. Do not locate gravity vented appliances between tumble dryer(s) and make-up air openings. If it is necessary to duct make-up air to tumble dryer(s), increase area of duct work by 25% to compensate for restrictions in air movement.

Venting

	WARNING
<p>To reduce the risk of fire due to increased static pressure, we do not recommend installation of in-line secondary lint filters or lint collectors. If secondary systems are mandated, frequently clean the system to assure safe operation.</p>	
W749	

IMPORTANT: Installing in-line filters or lint collectors will cause increased static pressure. Failure to maintain the secondary lint system will decrease tumble dryer efficiency and may void machine warranty.

For maximum efficiency and minimum lint accumulation, tumble dryer air must be exhausted to the outdoors by the shortest possible route.

Proper sized exhaust ducts are essential for proper operation. All elbows should be sweep type. Exhaust ducts must be assembled so the interior surfaces are smooth, so the joints do not permit the accumulation of lint. DO NOT use plastic, thin foil or Type

B flexible ducts - rigid metal ducts are recommended. Use exhaust ducts made of sheet metal or other noncombustible material. DO NOT use sheet metal screws or fasteners on exhaust pipe joints which extend into the duct and catch lint. Use of duct tape or pop-rivets on all seams and joints is recommended, if allowed by local codes.

Verify that old ducts are thoroughly cleaned out before installing new tumble dryer(s).

NOTE: Exhaust ducts must be constructed of sheet metal or other noncombustible material. Such ducts must be equivalent in strength and corrosion resistance to ducts made of galvanized sheet steel not less than 0.0195 inches (0.495 mm) thick.

Where the exhaust duct pierces a combustible wall or ceiling, the opening must be sized per local codes. The space around the duct may be sealed with noncombustible material. Refer to *Figure 10*.

IMPORTANT: For best performance provide an individual exhaust duct for each tumble dryer. Do not install a hot water heater in a room containing tumble dryers. It is better to have the water heater in a separate room with a separate air inlet.

	WARNING
<p>Improperly sized or assembled ductwork causes excess back pressure which results in slow drying, lint collecting in the duct, lint blowing back into the room, and increased fire hazard.</p>	
W355	

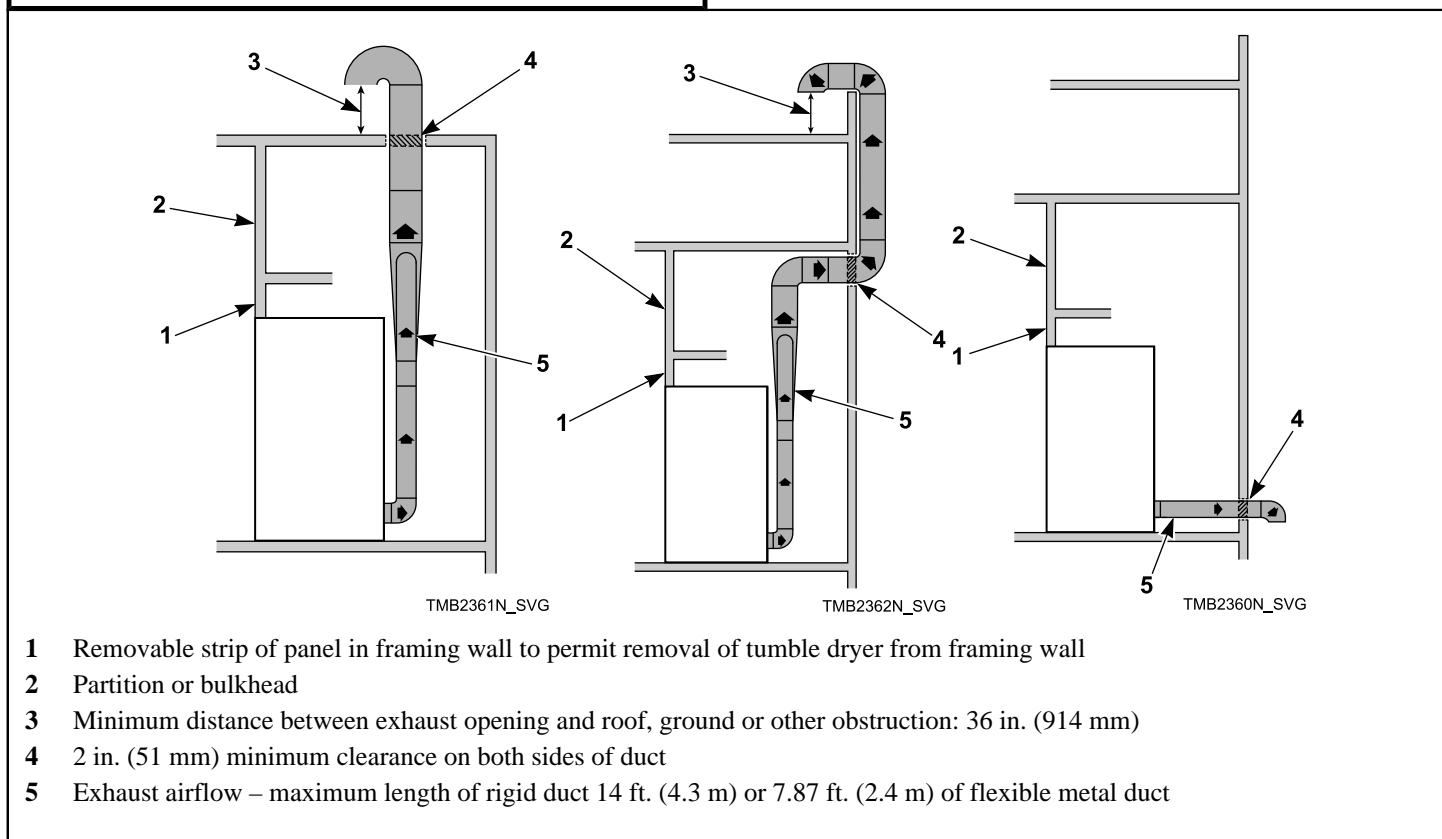

Figure 10

NOTE: Do not install wire mesh or screen in exhaust duct opening to avoid lint build-up or impacting proper discharge of air from tumble dryers.

NOTE: Where exhaust duct pierces a combustible wall or ceiling, the opening must be sized per local codes.

NOTE: Inside of duct must be smooth. Do not use sheet metal screws to join sections.

Consult your local building code for regulations which may also apply.

Alternate Venting for 120 Series Tumble Dryers

The 120 series tumble dryer is equipped from the factory to exhaust from the top; however, it may be converted to exhaust out the rear by doing the following (refer to Specifications and Dimensions section):

1. Remove belt guard cover.
2. Remove 10 inch (254 mm) diameter elbow and vertical duct.
3. Cut out shape from belt guard cover. Refer to *Figure 11*.
4. Screw octagonal piece over 10 inch (254 mm) diameter opening in top of belt guard.
5. Attach new exhaust duct to exhaust thimble on rear panel, following all requirements in this section.
6. Replace belt guard cover.

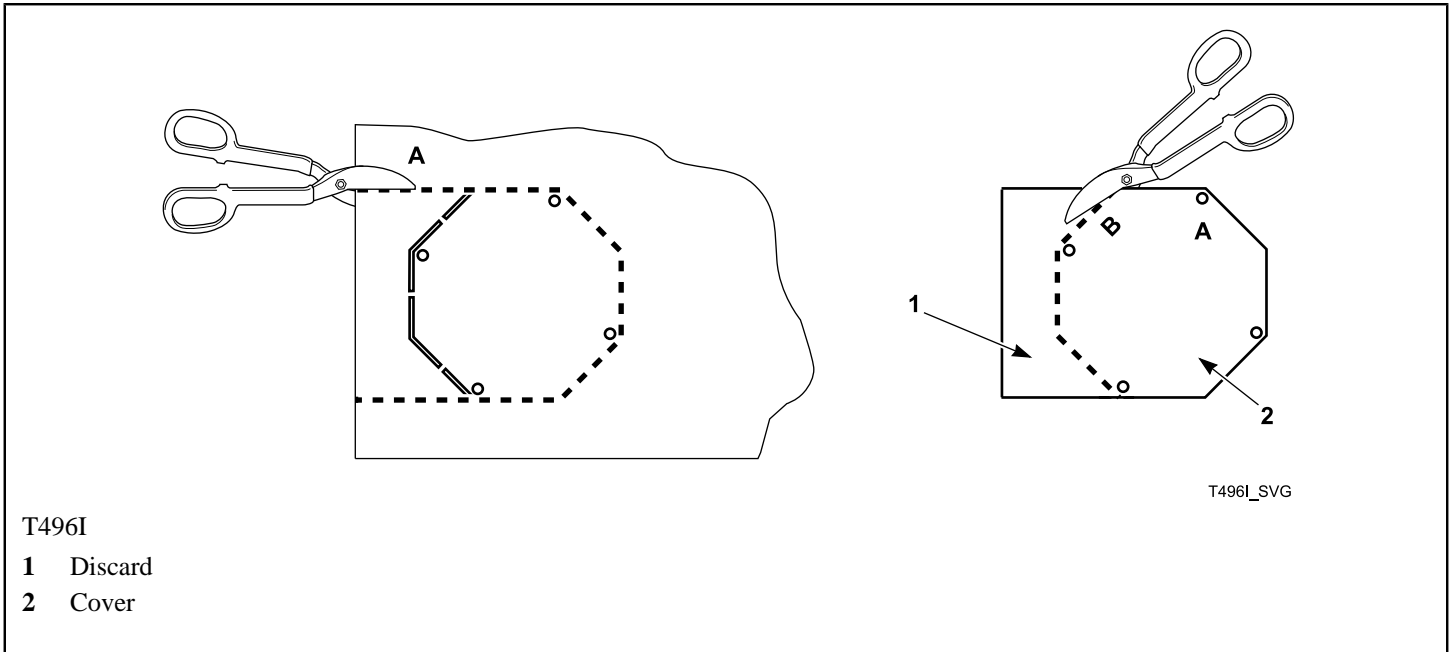

Figure 11

Individual Venting

For maximum efficiency and performance, it is preferred to exhaust tumble dryer(s) individually to the outdoors.

IMPORTANT: At no point may the cross sectional area of installed venting be less than the cross sectional area of the exhaust outlet of the tumble dryer.

The exhaust duct must be designed so the static back pressure measured 12 inches (305 mm) from the exhaust outlet does not exceed the maximum allowable pressure specified on the installation sticker on the rear of the tumble dryer.

NOTE: Static back pressure must be measured with the tumble dryer running.

The maximum allowable length venting is 14 feet (4.3 m) and two 90° elbows or equivalent. If the equivalent length of a duct required for an installation exceeds the maximum allowable equivalent length, the diameter of a round duct must be increased by 10% for each additional 20 feet (6.1 m). Cross section area of a rectangular duct must be increased by 20% for each additional 20 feet (6.1 m). Refer to *Table 3* to determine equivalent venting.

Duct Diameter	Equivalent Length of Rigid Straight Duct
10 in. (254 mm)	One 90° elbow = 11.6 ft. (3.5 m)
12 in. (305 mm)	One 90° elbow = 14 ft. (4.3 m)
14 in. (356 mm)	One 90° elbow = 16 ft. (4.9 m)
16 in. (406 mm)	One 90° elbow = 18.7 ft. (5.7 m)
18 in. (457 mm)	One 90° elbow = 21 ft. (6.4 m)

Duct Diameter	Equivalent Length of Rigid Straight Duct
Equivalent Length (meter) = 1.17 x Duct Diameter (mm)	

Table 3

Example: A 12 inch (305 mm) diameter duct's equivalent length of 14 feet (4.3 m) of duct and two 90° elbows is:

Equivalent Length

= 14 ft. (4.3 m) + (2) 90° elbows

= 14 ft. (4.3 m) + 14 ft. (4.3 m) + 14 ft. (4.3 m)

= 42 ft. (12.8 m)

With the tumble dryer in operation, airflow at any point in the duct should be at least 1200 feet/min. (366 m/min.) to ensure that lint remains airborne. If 1200 feet/min. (366 m/min.) per minute cannot be maintained, schedule monthly inspections and cleaning of the ductwork.

NOTE: The maximum length of a flexible metal duct must not exceed 7.87 ft. (2.4 m) as required to meet UL2158, clause 7.3.2A.

Manifold Venting

While it is preferable to exhaust tumble dryers individually to the outdoors, a main collector may be used if it is sized according to *Figure 13 One Manifold Assembly* and *Figure 14 Two Manifold Assemblies*. This illustration indicates minimum diameters, and should be increased if the collector length exceeds 14 feet (4.3 m) and two 90° elbows. The diameter of a

round duct must be increased by 10% for each additional 20 feet (6.1 m). Cross sectional area of a rectangular or square duct must be increased 20% for each additional 20 feet (6.1 m). Refer to *Table 4* to determine equivalent ducting sizing. The collector duct may be rectangular or square in cross section, as long as the area is not reduced. Provisions **MUST** be made for lint removal and cleaning of the collector duct.

The vent collector system must be designed so the static back pressure measured 12 inches (305 mm) from the exhaust outlet does not exceed the maximum allowable pressure of 0.5 W.C.I. (1.3 bar) as specified on the installation sticker on the rear of tumble dryer. Static back pressure must be measured with all tumble dryers vented into the collector operating.

NOTE: Never connect a tumble dryer duct at a 90° angle to the collector duct. Refer to *Figure 12*. Doing so will cause excessive back pressure, resulting in poor performance. Never connect two tumble dryer exhaust ducts directly across from each other at the point of entry to the collector duct.

With the tumble dryer in operation, airflow at any point in the duct should be at least 1200 feet/min. (366 m/min.) to ensure that lint remains airborne. If 1200 feet/min. (366 m/min.) cannot be maintained, schedule monthly inspections and cleaning of the ductwork.

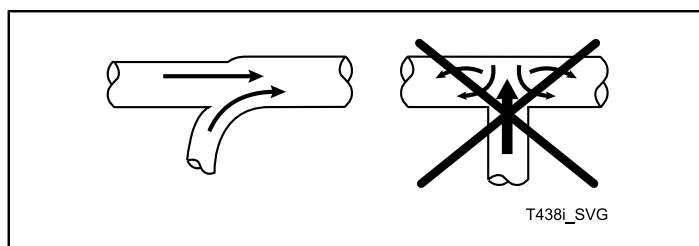
**Figure 12**

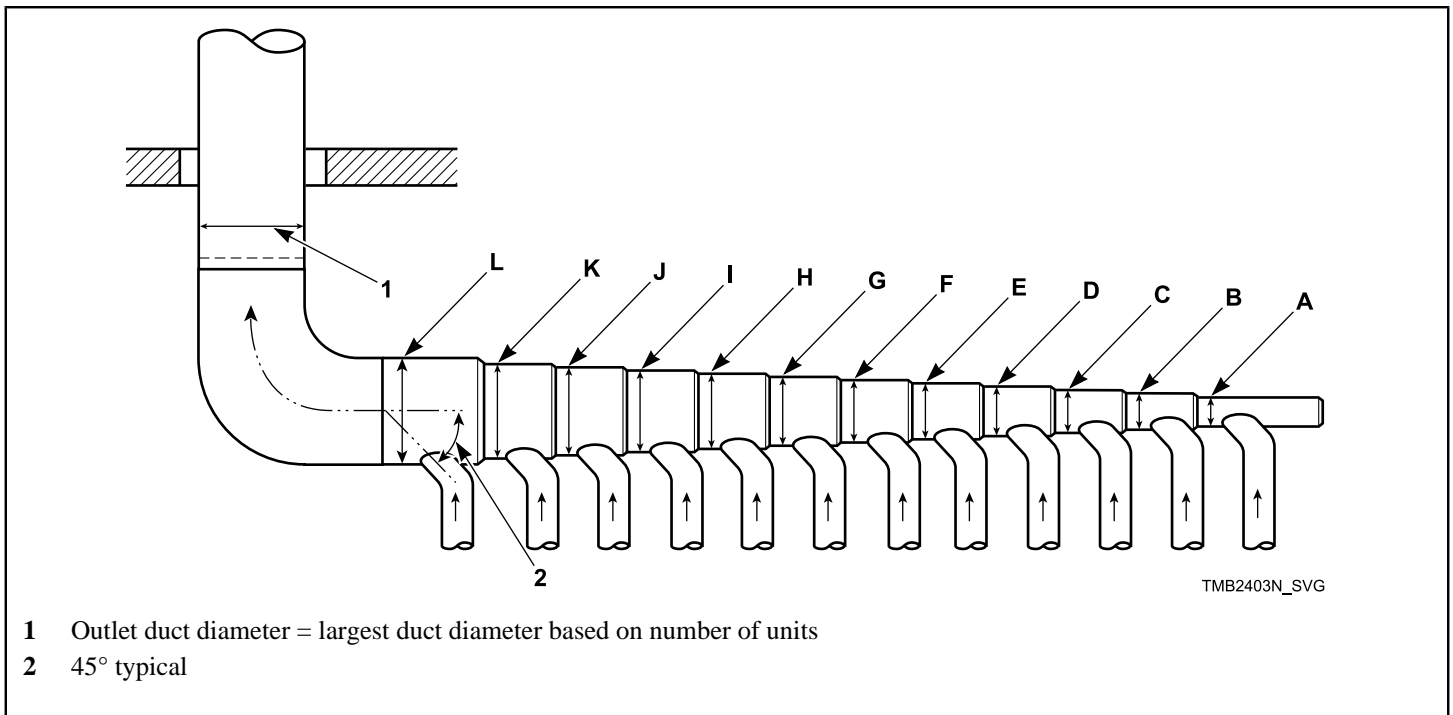

Figure 13 One Manifold Assembly

Duct Station	120 Series	170/200 Series
A	10 in. (254 mm)	12 in. (305 mm)
B	15 in. (381 mm)	17 in. (432 mm)
C	18 in. (457 mm)	21 in. (533 mm)
D	21 in. (533 mm)	24 in. (610 mm)
E	24 in. (610 mm)	27 in. (686 mm)
F	26 in. (660 mm)	30 in. (762 mm)
G	28 in. (711 mm)	32 in. (813 mm)
H	30 in. (762 mm)	34 in. (864 mm)
I	32 in. (813 mm)	36 in. (914 mm)
J	33 in. (838 mm)	38 in. (965 mm)
K	35 in. (889 mm)	40 in. (1,016 mm)

Duct Station	120 Series	170/200 Series
L	36 in. (914 mm)	42 in. (1,067 mm)

Table 4

NOTE: *Table 4* represents units with the same vent size. If multiple vent sizes are used, consult a local HVAC specialist.

NOTE: Duct clean-out recommended every 6 feet (183 cm) .

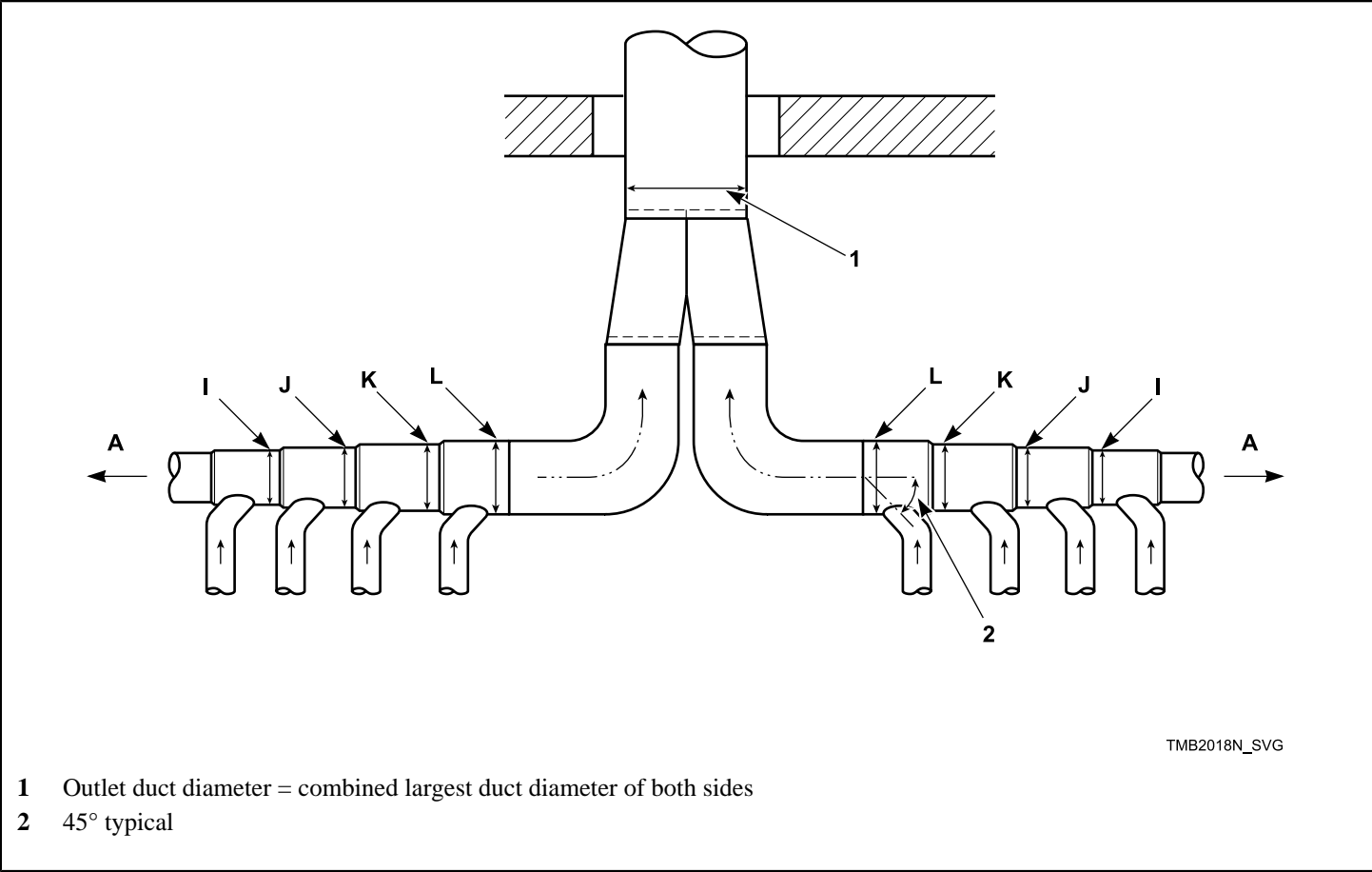



Figure 14 Two Manifold Assemblies

Refer to *Table 4* for measurements for each manifold.

Gas Requirements

Gas Requirements

	WARNING
<p>To reduce the risk of fire or explosion, DO NOT CONNECT THE GAS LINE TO THE TUMBLE DRYER IF THE GAS SERVICE IS NOT THE SAME AS THAT SPECIFIED ON THE TUMBLE DRYER SERIAL PLATE! It will first be necessary to convert the gas burner orifice and gas valve. Appropriate conversion kits are available.</p>	
W060R1	

	WARNING
<p>To reduce the risk of gas leaks, fire or explosion, use a new flexible stainless steel connector.</p>	
W774	

IMPORTANT: Any product revisions or conversions must be made by the Manufacturer's Authorized Dealers, Distributors or local service personnel.

IMPORTANT: The tumble dryer must be isolated from the gas supply piping system by closing its individual manual shut-off valve during any pressure testing of the gas supply piping system at test pressure equal to or less than 0.5 psig (3.45 kPa, 34.5 mbar).

NOTE: For gas valves with a manual shut-off switch on the gas valve, the shut-off switch does not protect the valve from this pressure test. Use the individual manual shut-off valve from the gas supply piping system to protect the gas valve.

IMPORTANT: The tumble dryer and its manually operated appliance gas valve must be disconnected from the gas supply piping system during any pressure testing of that system at test pressures in excess of 0.5 psig (3.45 kPa, 34.5 mbar).

IMPORTANT: The installation must comply with local codes or, in the absence of local codes:

- with the latest edition of the "National Fuel Gas Code," ANSI Z223.1/NFPA 54 in the U.S.A.
- with CAN/CSA-B149.1 Natural Gas and Propane Installation Code in Canada
- In Australia and New Zealand, installation must comply with the Gas Installations Standard AS/NZS 5601 Part 1: General Installations.

Obtain specific gas service pipe size from the gas supplier. Refer to *Table 5* for general pipe size.

The following must be furnished and installed by the customer for the gas service line to each tumble dryer. Refer to *Figure 15*.

- Sediment traps
- Shut-off valves
- Supply pressure taps

It is important that equal pressure be maintained at all tumble dryer gas connections. This can be done by installing a 1 inch (25.4 mm) pipe gas loop to maintain equal pressure at all gas connections. Refer to *Figure 16*.

	WARNING
<p>To reduce the risk of fire or explosion, if the tumble dryer is to be connected to Liquefied Petroleum (L.P.) gas, a vent to the outdoors must be provided in the room where the tumble dryer is installed.</p>	
W062R1	

NATURAL GAS pressures with all gas appliances running (tumble dryers, water heaters, space heaters, furnace, etc.):

Maximum gas pressure – 10.5 water column inches (26.1 mbar, 2.61 kPa)

Recommended gas pressure – 6.5 water column inches (16.2 mbar, 1.62 kPa)

Minimum gas pressure – 5 water column inches (12.4 mbar, 1.24 kPa)

An in-line pressure regulator may be required if the line pressure exceeds 10.5 water column inches (26.1 mbar, 2.61 kPa) with all gas appliances running.

LIQUID PETROLEUM GAS (L.P.) pressures with all gas appliances running (tumble dryers, water heaters, space heaters, furnace, etc.):

Maximum gas pressure – 13 water column inches (32.3 mbar, 3.23 kPa)

Recommended gas pressure – 11 water column inches (27.4 mbar, 2.74 kPa)

Minimum gas pressure – 10 water column inches (24.9 mbar, 2.49 kPa)

For converting Non-CE models from Natural Gas to L.P. Gas:

Model	Hertz	Date Range	Part No.
120	60	Through 2/14/11	M4577P3
120	60	Starting 2/15/11	M4578P3
120	50	Through 2/14/11	M4973P3
120	50	Starting 2/15/11	M4975P3
170	60	-	M4592P3
170	50	-	M4974P3
200	50 and 60	-	44257701

CE GASES refer to Installing CE Gas Drying Tumble Dryers section, the above data does not apply to the CE.

Turn on gas and check all pipe connections (internal and external) for gas leaks with a non-corrosive leak detection fluid. Purge air in gas service line by operating the tumble dryers in the drying mode. If burner does not light and unit goes into lockout, open and close the door and restart. Repeat these steps until burner ignites. Use pipe compound, resistant to actions of L.P. gas, on all pipe threads.



WARNING

Check all pipe connections, internal and external, for gas leaks using a non-corrosive leak detection fluid. To reduce the risk of explosion or fire, DO NOT USE AN OPEN FLAME TO CHECK FOR GAS LEAKS! Gas connections should be checked twice a year for leakage.

W635

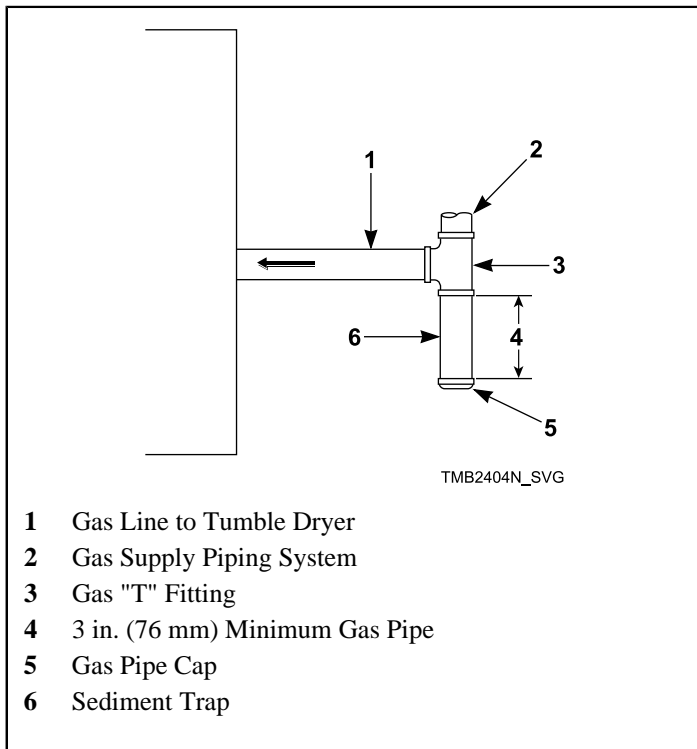
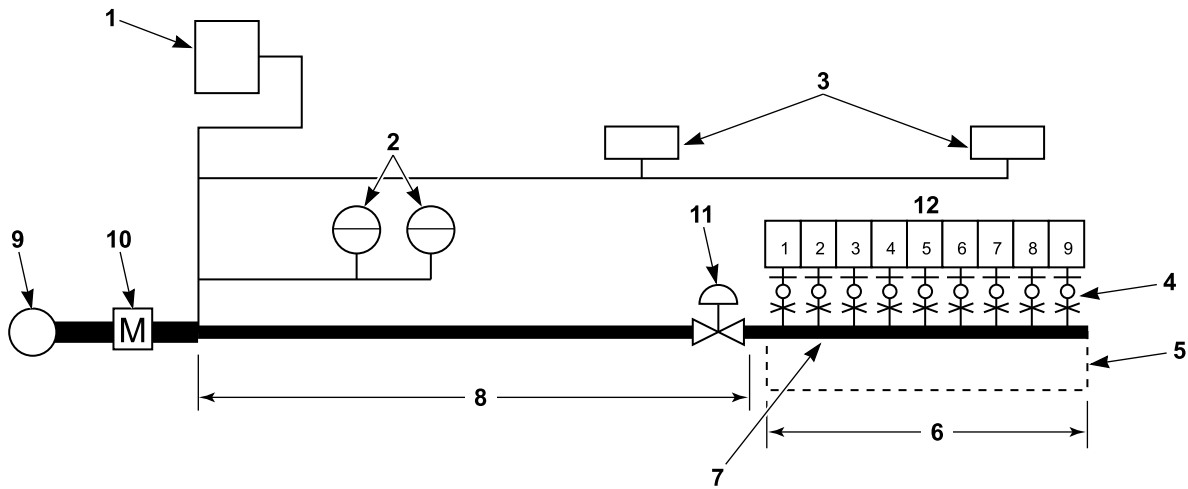

Figure 15

Gas Supply Pipe Sizing and Looping



TMB2126N_SVG

SAMPLE CALCULATIONS:

Equivalent length = Total length of main gas supply pipe to the far end of the tumble dryers.
 = 25 ft. + 19 ft. (7.6 m + 5.8 m) gas supply pipe
 = 44 ft. (13.4 m) Total Gas Line

Total Btu/hr. = The sum of the Btu/hr. of all 120 series tumble dryers being fed by the main gas supply pipe.
 = 9 x 270,000 (285, 79.13)
 = 2,430,000 Btu/hr. (2,564 MJ/hr., 712.17 kW)

Using *Gas Pipe Size Required for 1000 Btu Natural Gas* — , the main supply pipe diameter should be 3 in. (76 mm).

IMPORTANT: Gas loop piping must be installed as illustrated to equalize gas pressure for all tumble dryers connected to single gas service. Other gas using appliances should be connected upstream from loop.

- 1 Gas furnace [120,000 Btu/hr. (127 MJ/hr., 35.2 kW)]
- 2 Gas water heaters [400,000 Btu/hr. (422 MJ/hr., 117.2 kW) each]
- 3 Gas space heaters [70,000 Btu/hr. (79 MJ/hr., 20.5 kW) each]
- 4 Sediment traps, supply pressure taps and shut-off valves. Refer to *Figure 15* .
- 5 1 in. (25.4 mm) gas pipe loop
- 6 19 ft. (5.8 m)
- 7 Minimum Pipe Size is 0.75 in. (19 mm) for 120 Series Gas, 1 in. (25.4 mm) for 170 and 200 Series Gas.
- 8 25 ft. (7.6 m)
- 9 Main regulator
- 10 Gas meter
- 11 Pressure regulator (if required)
- 12 120 series tumble dryers = 270,000 Btu/hr. (285 MJ/hr., 79.13 kW) each; 170 series tumble dryers = 395,000 Btu/hr. (417 MJ/hr., 115.77 kW) each; 200 series tumble dryers = 425,000 Btu/hr. (448 MJ/hr., 124.56 kW) each

Figure 16

Gas Pipe Size Required for 1000 Btu Natural Gas — 0.64 Specific Gravity at 7 ± 1.5 inches (17.4 ± 4 mbar, 1.74 ± 0.37 kPa) Water Column Pressure						
Gas Appliances Total Btu/hr.	Equivalent Length					
	25 feet (7.63 m)	50 feet (15.25 m)	75 feet (22.88 m)	100 feet (30.50 m)	125 feet (38.13 m)	150 feet (45.75 m)
	Based on 0.3 in. Water Column Pressure Drop for Length Given Sizes shown in inches (mm)					
100,000	0.75 (19.05)	0.75 (19.05)	1 (25.40)	1 (25.40)	1 (25.40)	1 (25.40)
120,000	0.75 (19.05)	1 (25.40)	1 (25.40)	1 (25.40)	1 (25.40)	1 (25.40)
140,000	0.75 (19.05)	1 (25.40)	1 (25.40)	1 (25.40)	1 (25.40)	1.25 (31.75)
160,000	0.75 (19.05)	1 (25.40)	1 (25.40)	1.25 (31.75)	1.25 (31.75)	1.25 (31.75)
180,000	1 (25.40)	1 (25.40)	1 (25.40)	1.25 (31.75)	1.25 (31.75)	1.25 (31.75)
200,000	1 (25.40)	1 (25.40)	1.25 (31.75)	1.25 (31.75)	1.25 (31.75)	1.5 (38.10)
300,000	1 (25.40)	1.25 (31.75)	1.25 (31.75)	1.5 (38.10)	1.5 (38.10)	1.5 (38.10)
400,000	1.25 (31.75)	1.25 (31.75)	1.5 (38.10)	1.5 (38.10)	1.5 (38.10)	2 (50.80)
500,000	1.25 (31.75)	1.5 (38.10)	1.5 (38.10)	2 (50.80)	2 (50.80)	2 (50.80)
600,000	1.5 (38.10)	1.5 (38.10)	2 (50.80)	2 (50.80)	2 (50.80)	2 (50.80)
700,000	1.5 (38.10)	2 (50.80)	2 (50.80)	2 (50.80)	2 (50.80)	2.5 (63.50)
800,000	1.5 (38.10)	2 (50.80)	2 (50.80)	2 (50.80)	2.5 (63.50)	2.5 (63.50)
900,000	2 (50.80)	2 (50.80)	2 (50.80)	2.5 (63.50)	2.5 (63.50)	2.5 (63.50)
1,000,000	2 (50.80)	2 (50.80)	2 (50.80)	2.5 (63.50)	2.5 (63.50)	2.5 (63.50)
1,100,000	2 (50.80)	2 (50.80)	2.5 (63.50)	2.5 (63.50)	2.5 (63.50)	2.5 (63.50)
1,200,000	2 (50.80)	2 (50.80)	2.5 (63.50)	2.5 (63.50)	2.5 (63.50)	2.5 (63.50)

Gas Pipe Size Required for 1000 Btu Natural Gas — 0.64 Specific Gravity at 7 ± 1.5 inches (17.4 ± 4 mbar, 1.74 ± 0.37 kPa) Water Column Pressure						
Gas Appliances Total Btu/hr.	Equivalent Length					
	25 feet (7.63 m)	50 feet (15.25 m)	75 feet (22.88 m)	100 feet (30.50 m)	125 feet (38.13 m)	150 feet (45.75 m)
	Based on 0.3 in. Water Column Pressure Drop for Length Given Sizes shown in inches (mm)					
1,300,000	2 (50.80)	2.5 (63.50)	2.5 (63.50)	2.5 (63.50)	2.5 (63.50)	3 (76.20)
1,400,000	2 (50.80)	2.5 (63.50)	2.5 (63.50)	2.5 (63.50)	3 (76.20)	3 (76.20)
1,500,000	2 (50.80)	2.5 (63.50)	2.5 (63.50)	2.5 (63.50)	3 (76.20)	3 (76.20)
1,600,000	2 (50.80)	2.5 (63.50)	2.5 (63.50)	3 (76.20)	3 (76.20)	3 (76.20)
1,700,000	2 (50.80)	2.5 (63.50)	2.5 (63.50)	3 (76.20)	3 (76.20)	3 (76.20)
1,800,000	2.5 (63.50)	2.5 (63.50)	3 (76.20)	3 (76.20)	3 (76.20)	3 (76.20)
1,900,000	2.5 (63.50)	2.5 (63.50)	3 (76.20)	3 (76.20)	3 (76.20)	3 (76.20)
2,000,000	2.5 (63.50)	2.5 (63.50)	3 (76.20)	3 (76.20)	3 (76.20)	3.5 (88.90)
2,200,000	2.5 (63.50)	3 (76.20)	3 (76.20)	3 (76.20)	3.5 (88.90)	3.5 (88.90)
2,400,000	2.5 (63.50)	3 (76.20)	3 (76.20)	3 (76.20)	3.5 (88.90)	3.5 (88.90)
2,600,000	2.5 (63.50)	3 (76.20)	3 (76.20)	3.5 (88.90)	3.5 (88.90)	3.5 (88.90)
2,800,000	2.5 (63.50)	3 (76.20)	3 (76.20)	3.5 (88.90)	3.5 (88.90)	3.5 (88.90)
3,000,000	2.5 (63.50)	3 (76.20)	3.5 (88.90)	3.5 (88.90)	3.5 (88.90)	4 (101.60)

For L.P. Gas, correct the total Btu/hr by multiplying it by 0.6. The answer is the equivalent Btu on the above chart.

Table 5

High Altitude Orifice Sizing

For proper operation at altitudes above 2000 feet (610 meters), the gas orifice size must be reduced to ensure complete combustion. Refer to *Table 6*.

For CE models, consult local gas supplier.

Model	Gas	Altitude	Orifice				New Rate
		feet (m)	No.	inches (mm)	Quantity	Part No.	Btu/hr.* (Mj/hr.)
120L/N	Natural Gas	2,001 – 4,000 (610 – 1,220)	18	0.1695 (4.3)	3	M402988	248,400 (262)
		4,001 – 6,000 (1,221 – 1,830)	19	0.1660 (4.2)		M402995	226,800 (239)
		6,001 – 8,000 (1,831 – 2,440)	21	0.1590 (4)		M402992	205,200 (216)
		8,001 – 10,000 (2,441 – 3,050)	24	0.1520 (3.9)		M402980	183,600 (194)
	L.P. Gas	2,001 – 4,000 (610 – 1,220)	38	0.1015 (2.6)		M411376	248,400 (262)
		4,001 – 6,000 (1,221 – 1,830)	40	0.0980 (2.5)		M406361	226,800 (239)
		6,001 – 8,000 (1,831 – 2,440)	42	0.0935 (2.4)		M403017	205,200 (216)
		8,001 – 10,000 (2,441 – 3,050)	43	0.0890 (2.3)		M406184	183,600 (194)
170L/N	Natural Gas	2,001 – 4,000 (610 – 1,220)	16	0.1770 (4.5)	4	M411373	363,400 (383)
		4,001 – 6,000 (1,221 – 1,830)	11/64	0.1719 (4.4)		44249901	331,800 (350)
		6,001 – 8,000 (1,831 – 2,440)	19	0.1660 (4.2)		M402995	300,200 (317)
		8,001 – 10,000 (2,441 – 3,050)	22	0.1570 (4)		M402996	268,600 (283)

Model	Gas	Altitude	Orifice				New Rate
		feet (m)	No.	inches (mm)	Quantity	Part No.	Btu/hr.* (Mj/hr.)
	L.P. Gas	2,001 – 4,000 (610 – 1,220)	1/8	0.1250 (3.2)	3	M402489	363,400 (383)
		4,001 – 6,000 (1,221 – 1,830)	31	0.1200 (3)		M401017	331,800 (350)
		6,001 – 8,000 (1,831 – 2,440)	32	0.1160 (2.9)		M402444	300,200 (317)
		8,001 – 10,000 (2,441 – 3,050)	34	0.1110 (2.8)		M411512	268,600 (283)
200L/N	Natural Gas	2,001 – 4,000 (610 – 1,220)	12	0.1890 (4.8)	4	M411372	391,000 (413)
		4,001 – 6,000 (1,221 – 1,830)	14	0.1820 (4.6)		M411371	357,000 (377)
		6,001 – 8,000 (1,831 – 2,440)	17	0.1730 (4.4)		M411374	323,000 (341)
		8,001 – 10,000 (2,441 – 3,050)	19	0.1660 (4.2)		M402995	289,000 (305)
	L.P. Gas	2,001 – 4,000 (610 – 1,220)	30	0.1285 (—)	3	M401021	391,000 (413)
		4,001 – 6,000 (1,221 – 1,830)	1/8	0.1250 (3.2)		M402489	357,000 (377)
		6,001 – 8,000 (1,831 – 2,440)	31	0.1200 (3)		M401017	323,000 (341)
		8,001 – 10,000 (2,441 – 3,050)	33	0.1130 (2.9)		M401022	289,000 (305)

*Btu/hr. derate of 4% per 1,000 ft. (305 m) of altitude.

Table 6

Electrical Requirements

Electrical Requirements

	WARNING
<p>To reduce the risk of electric shock, fire, explosion, serious injury or death:</p> <ul style="list-style-type: none"> • Disconnect electric power to the tumble dryer before servicing. • Close gas shut-off valve to gas tumble dryer before servicing. • Close steam valve to steam tumble dryer before servicing. • Never start the tumble dryer with any guards/panels removed. • Whenever ground wires are removed during servicing, these ground wires must be reconnected to ensure that the tumble dryer is properly grounded. 	
W002R1	

	WARNING
<p>To reduce the risk of fire and electric shock, check with a qualified service person for proper grounding procedures. Improper connection of the equipment grounding conductor may result in a risk of electric shock.</p>	
W068R1	

	WARNING
<p>To reduce the risk of fire and electric shock, if electrical supply is coming from a three phase service, DO NOT connect a “High Leg” or “Stinger Leg” to a single phase machine. On a three phase machine, if there is a “High Leg” or “Stinger Leg” it should be connected to L3.</p>	
W069	

IMPORTANT: Electrical connections must be made by a qualified electrician using data on serial plate, installation manuals and wiring diagram provided with machine and according to local codes. Install a circuit breaker as close to the tumble dryer as possible. If more than one tumble dryer is being installed, a circuit breaker must be provided for each.

NOTE: Connect machine to an individual branch circuit not shared with lighting or other equipment.

NOTE: 3 Phase Machines Only - Do not use fuses to avoid the possibility of “single phasing” and causing premature failure of the motors.

	WARNING
<p>In case of servicing (or putting the tumble dryer out of order), disconnect the tumble dryer from the main supply by switching off the circuit breaker.</p>	
W796	

Wiring Diagram

The wiring diagram is located in the junction or contactor box.

The wiring diagram part number is in the lower portion of the electrical data on the serial plate.

Grounding Instructions

NOTE: To ensure protection against shock, this tumble dryer **MUST** be electrically grounded in accordance with the local codes, or in the absence of local codes, with the latest edition of the National Electrical Code ANSI/NFPA No. 70. In Canada the electrical connections are to be made in accordance with CSA C22.1 latest edition Canadian Electrical Code, or local codes. Electrical work should be done by a qualified electrician.

This tumble dryer must be grounded. In the event of malfunction or breakdown, grounding will reduce the risk of electric shock by providing a path of least resistance for electric current. This tumble dryer must be connected to a grounded metal, permanent wiring system; or an equipment grounding conductor must be run with the circuit conductors and connected to the appropriate ground location.

- Metal conduit and/or BX cable is not considered ground.
- Connecting the Neutral from the electrical service box to the tumble dryer ground screw does not constitute a ground.
- A dedicated ground conduit (wire) must be connected between the electrical service box ground bar and tumble dryer ground screw.

	<h2 style="margin: 0;">WARNING</h2>
<p>To reduce the risk of electrical shock, de-energize the electrical circuit being connected to the tumble dryer before making any electrical connections. All electrical connections should be made by a qualified electrician. Never attempt to connect a live circuit.</p>	
<p>W409R1</p>	

	<h2 style="margin: 0;">CAUTION</h2>
<p>Label all wires prior to disconnection when servicing controls. Wiring errors can cause improper and dangerous operation. Verify proper operation after servicing.</p>	
<p>W071</p>	

For CE Models Only

All models are factory-equipped with an emergency stop button on the front panel.

NOTE: Activation of the emergency stop switch stops all machine control circuit functions, but DOES NOT remove all electrical power from machine.

Service/Ground Location

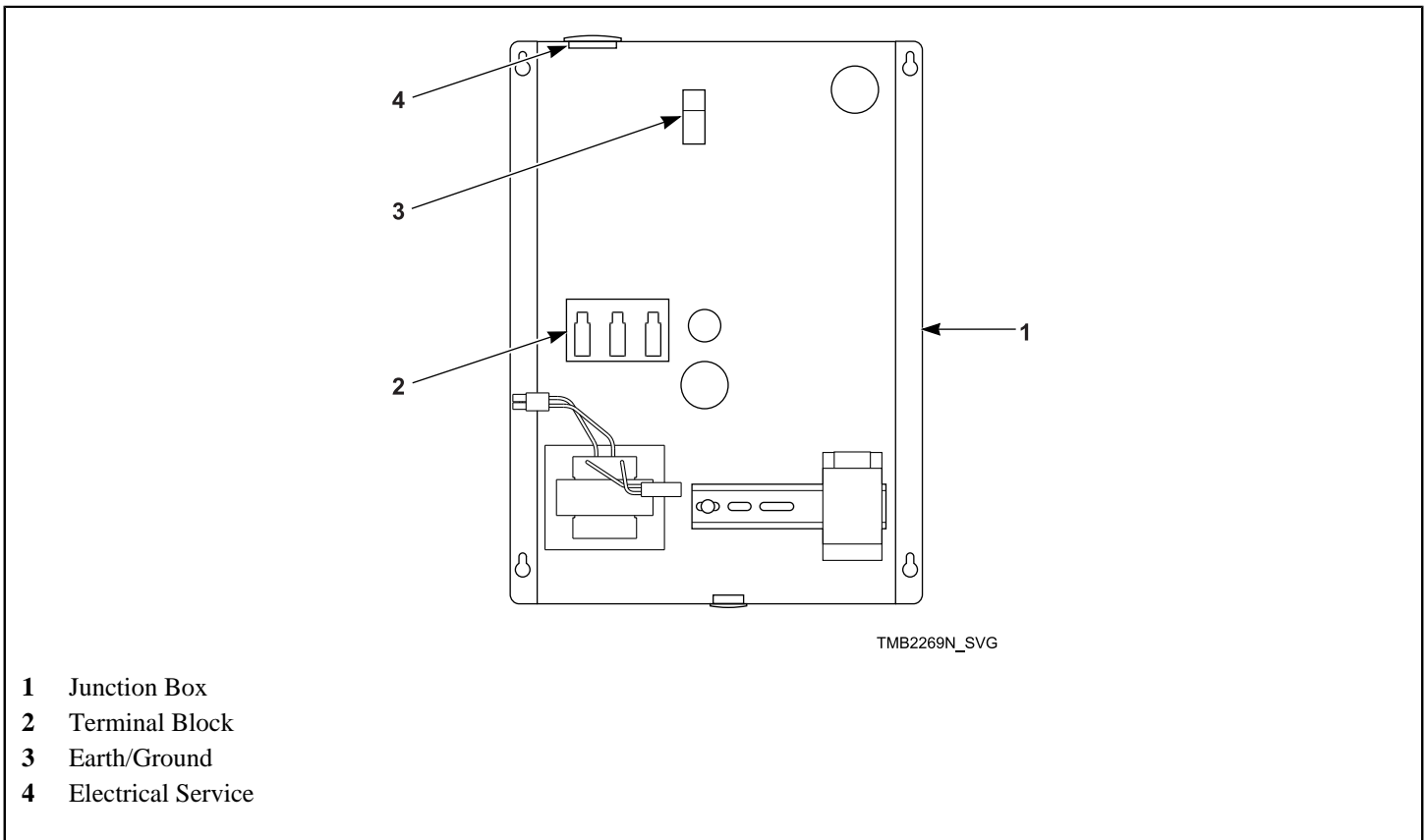

Figure 17 Ground and Terminal Block Locations for Non-CE Gas and Steam Models

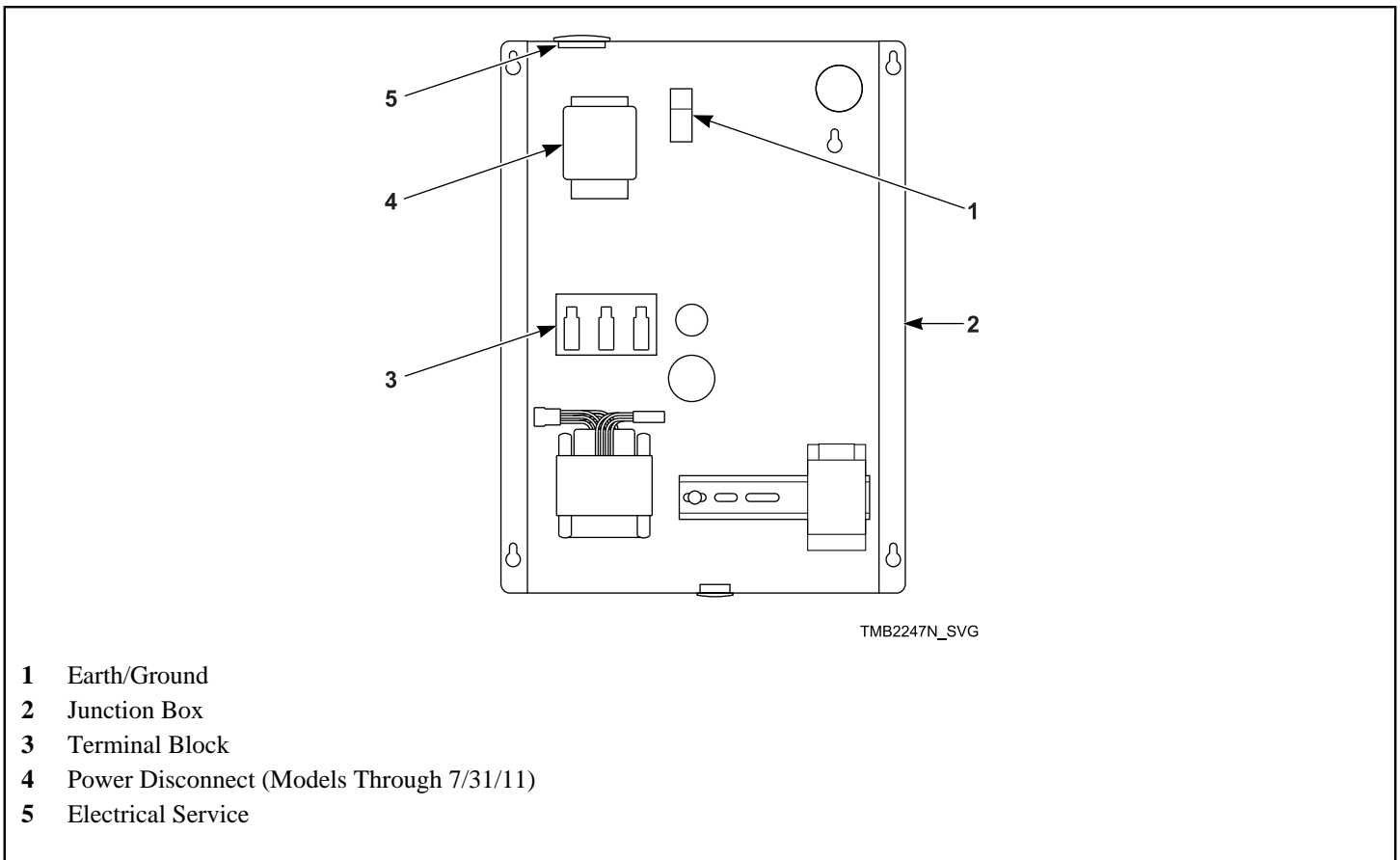

Figure 18 Ground and Terminal Block Locations for CE Gas and Steam Models

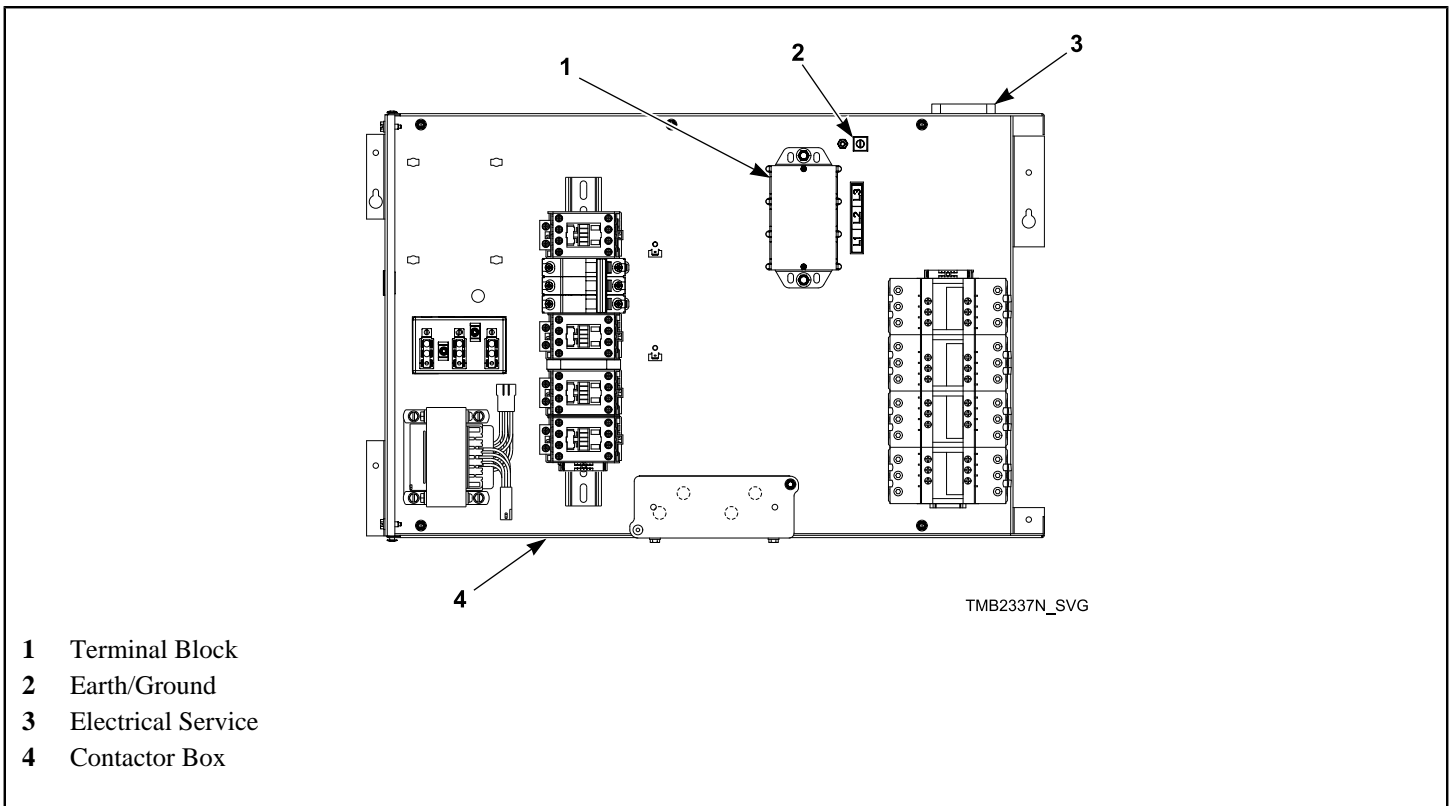

Figure 19 Ground and Terminal Block Locations for Electric Models

To Connect Electrical Service To The Tumble Dryer

The following steps outline the procedure for connecting the electrical service to the tumble dryer.

NOTE: The wiring diagram is located in the junction box.

1. Install a circuit breaker as close to the tumble dryer as possible. If more than one tumble dryer is being installed, a disconnect switch or circuit breaker should be provided for each. This will make it possible to disconnect each tumble dryer for maintenance purposes.
2. Connect the conduit-encased leads to the disconnect switch, or circuit breaker. Connect the wire leads to the appropriate labeled terminal on the terminal block. The ground wire must be connected to the ground connection as shown in *Figure 17 Ground and Terminal Block Locations for Non-CE Gas and Steam Models*, *Figure 18 Ground and Terminal Block Locations for CE Gas and Steam Models* or *Figure 19 Ground and Terminal Block Locations for Electric Models*.

Ferrite Ring Installation

Gas and Steam Models with RM Control Suffix Only (Models Through 7/31/11)

The ferrite ring provided in the literature packet must be installed over the power leads during connection of electrical service. The ferrite protects the sensitive electronic controls from destructive electrical disturbances which may be present

3. Check the electrical service phase sequence (three phase only). If one of the power leads is a “high leg,” connect it to lead L3 in the tumble dryer. The cylinder must rotate clockwise and the fan must rotate counterclockwise (as viewed from the front of the tumble dryer – with selector switch in non-reverse position). If not, interchange leads L1 and L2 in the tumble dryer connection box.

Jumper Configuration Instructions

Changing the transformer configuration jumper is required, **PRIOR TO SUPPLYING POWER TO THE MACHINE**, if any of the following apply:

IMPORTANT: Failure to install the proper configuration jumper may result in damage to sensitive electronic controls and may void warranty.

- You have 400 – 415 Volt service and are connecting a model rated for 380 Volt operation.

on power lines to the machine. Failure to properly install the ferrite ring may result in damage to the electronic controls and will void control warranty.

To install:

1. Immediately after connection of power leads and before applying power to machine, locate each of the incoming service leads including ground.
2. Snap the ferrite ring closed over all the service leads inside of the contactor box as shown. It is important that the ferrite

ring be installed inside the contactor box. Refer to *Figure 20* . Do not install the ferrite outside of the box or other area. Make sure that service leads are in the center of the ferrite before closing the ring so as not to pinch or damage leads.

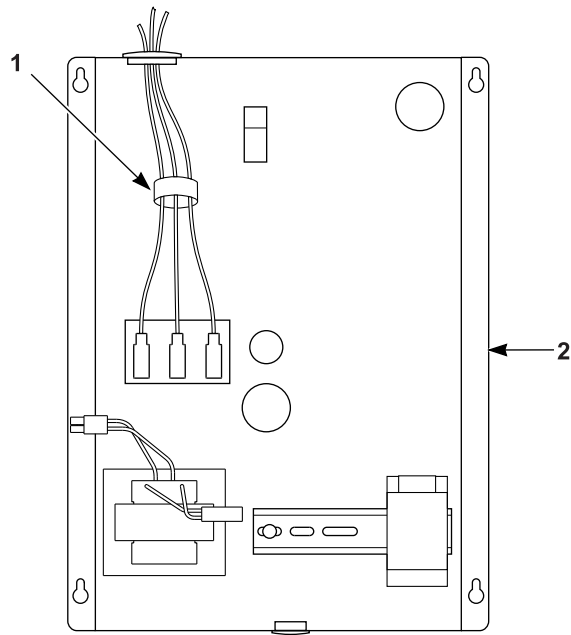

Non-CE Models

TMB2270N_SVG

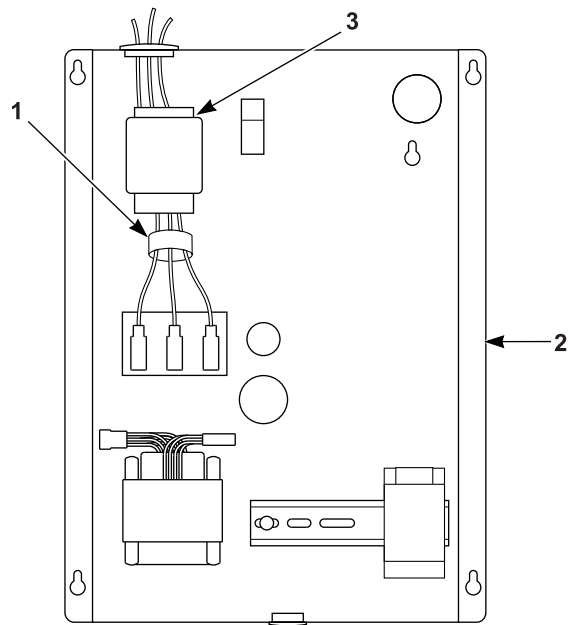

CE Models

TMB2271N_SVG

- 1 Ferrite Ring
- 2 Junction Box
- 3 Models Through 7/31/11

Figure 20

Electrical Specifications

NOTE: Minimum wire sizes are obtained from Canadian Electrical Code and are intended for use as a guideline only. Electrical connections should be made only by a qualified electrical contractor in accordance with all applicable local and national requirements.

NOTE: Electrical specifications below are subject to change without notice. Always refer to product serial plate for most current specifications of product being installed.

NOTE: Use copper conductors only.

NOTE: Connect to individual branch circuit.

NOTE: 3 Phase Only – Each tumble dryer must be connected to its own individual branch circuit breaker, not fuses, to avoid the possibility of “single phasing” and causing premature failure of the motor(s).

Serial Plate Rating	Terminal Block Connections Required	Rated Current* (amps)	Breaker Rating	Recommended Wire Size AWG (mm ²)
200-208/240V/60Hz/3ph	L1,L2,L3 and ground	7.7	15A - 3 pole	14 (2.5)
230V/50Hz/3ph	L1,L2,L3 and ground	7.3	15A - 3 pole	14 (2.5)
380V/50 or 60Hz/3ph	L1,L2,L3 and ground	4.1	10A - 3 pole	14 (2.5)
400-415V/50Hz/3ph	L1,L2,L3 and ground	3.8	10A - 3 pole	14 (2.5)
440V/60Hz/3ph	L1,L2,L3 and ground	3.8	10A - 3 pole	14 (2.5)
460-480V/60Hz/3ph	L1,L2,L3 and ground	3.9	10A - 3 pole	14 (2.5)
* Current ratings vary slightly depending on model; refer to serial plate.				

Table 7 For 120 Series Gas and Steam Tumble Dryer Models

Serial Plate Rating	Terminal Block Connections Required	Rated Current* (amps)	Breaker Rating	Recommended Wire Size AWG (mm ²)
240V/60Hz/3ph	L1,L2,L3 and ground	152	175A - 3 pole	3/0 (95)
380V/50 or 60Hz/3ph	L1,L2,L3 and ground	94.5	125A - 3 pole	1 (35)
400-415V/50Hz/3ph	L1,L2,L3 and ground	87	125A - 3 pole	1 (35)
480V/60Hz/3ph	L1,L2,L3 and ground	76.1	100A - 3 pole	3 (26.2)

Serial Plate Rating	Terminal Block Connections Required	Rated Current* (amps)	Breaker Rating	Recommended Wire Size AWG (mm²)
----------------------------	--	------------------------------	-----------------------	---

* Current ratings vary slightly depending on model; refer to serial plate.

Table 8 For 120 Series Electric Tumble Dryer Models

Serial Plate Rating	Terminal Block Connections Required	Rated Current* (amps)	Breaker Rating	Recommended Wire Size AWG (mm²)
200-208/240V/60Hz/3ph	L1,L2,L3 and ground	13.5	20A - 3 pole	12 (4)
380V/50 or 60Hz/3ph	L1,L2,L3 and ground	6.9	15A - 3 pole	14 (2.5)
400-415V/50Hz/3ph	L1,L2,L3 and ground	6.9	15A - 3 pole	14 (2.5)
440V/60Hz/3ph	L1,L2,L3 and ground	6.4	15A - 3 pole	14 (2.5)
460-480V/60Hz/3ph	L1,L2,L3 and ground	6.7	15A - 3 pole	14 (2.5)

* Current ratings vary slightly depending on model; refer to serial plate.

Table 9 For 170 Series Tumble Dryer Models

Serial Plate Rating	Terminal Block Connections Required	Rated Current* (amps)	Breaker Rating	Recommended Wire Size AWG (mm²)
200-208/240V/60Hz/3ph	L1, L2, L3 and ground	14	20A - 3 pole	12 (4)
380V/50Hz/3ph	L1, L2, L3 and ground	8	15A - 3 pole	14 (2.5)
400-415V/50Hz/3ph	L1, L2, L3 and ground	8	15A - 3 pole	14 (2.5)
440V/60Hz/3ph	L1, L2, L3 and ground	7	15A - 3 pole	14 (2.5)
460-480V/60Hz/3ph	L1, L2, L3 and ground	7	15A - 3 pole	14 (2.5)

Serial Plate Rating	Terminal Block Connections Required	Rated Current* (amps)	Breaker Rating	Recommended Wire Size AWG (mm²)
* Current ratings vary slightly depending on model; refer to serial plate.				

Table 10 For 200 Series Tumble Dryer Models

Steam Requirements

Steam Requirements

NOTE: Machines require a constant 80 to 100 psig (5.3 to 6.9 bar) steam service for optimum operation. The maximum allowable steam pressure for use with 50 Hertz tumble dryers is 125 psig (8.6 bar) . In no case may the pressure exceed the above value.

Obtain specific steam service pipe sizes from steam system supplier or a qualified steam fitter.

- Refer to *Figure 21 120 Series Tumble Dryers* and *Figure 22 170 and 200 Series Tumble Dryers* for proper steam pipe configurations.
- To prevent condensate draining from headers to tumble dryer, piping should have a minimum 12 inch (305 mm) rise above respective header. Do not make steam connection to header with a horizontal or downward facing tee or elbow.
- Whenever possible, horizontal runs of steam lines must drain, by gravity, to respective steam header. Water pockets, or an improperly drained steam header will provide wet steam, causing improper operation of tumble dryer. If pockets or improper drainage cannot be eliminated, install a bypass trap to drain condensate from the low point in the steam header to the return.

- In both steam supply and steam return line, it is recommended that each have a pipe union and shut-off valve. This will enable you to disconnect the steam connections and service the tumble dryer while your laundry facility is in operation.
- Connect the steam solenoid valve to the related steam coil inlet connection with nipples, flex hoses, unions and tees.
- Strainers may require cleaning due to materials from hoses or pipes.
- Install vacuum breaker (optional), bucket trap with built-in strainer and check valve. For successful operation of tumble dryer, install trap 18 inches (457 mm) below coil and as near to the tumble dryer as possible. Inspect trap carefully for inlet and outlet markings and install according to trap manufacturer's instructions. If steam is gravity returned to boiler, omit trap but install vacuum breaker and check valve in return line near tumble dryer. Gravity return requires entire return plumbing be below steam coil outlets.
- Install union and shut-off valve in return line and make final pipe connections to return header.

NOTE: To prevent water hammering, route return lines below outlets of steam coils.

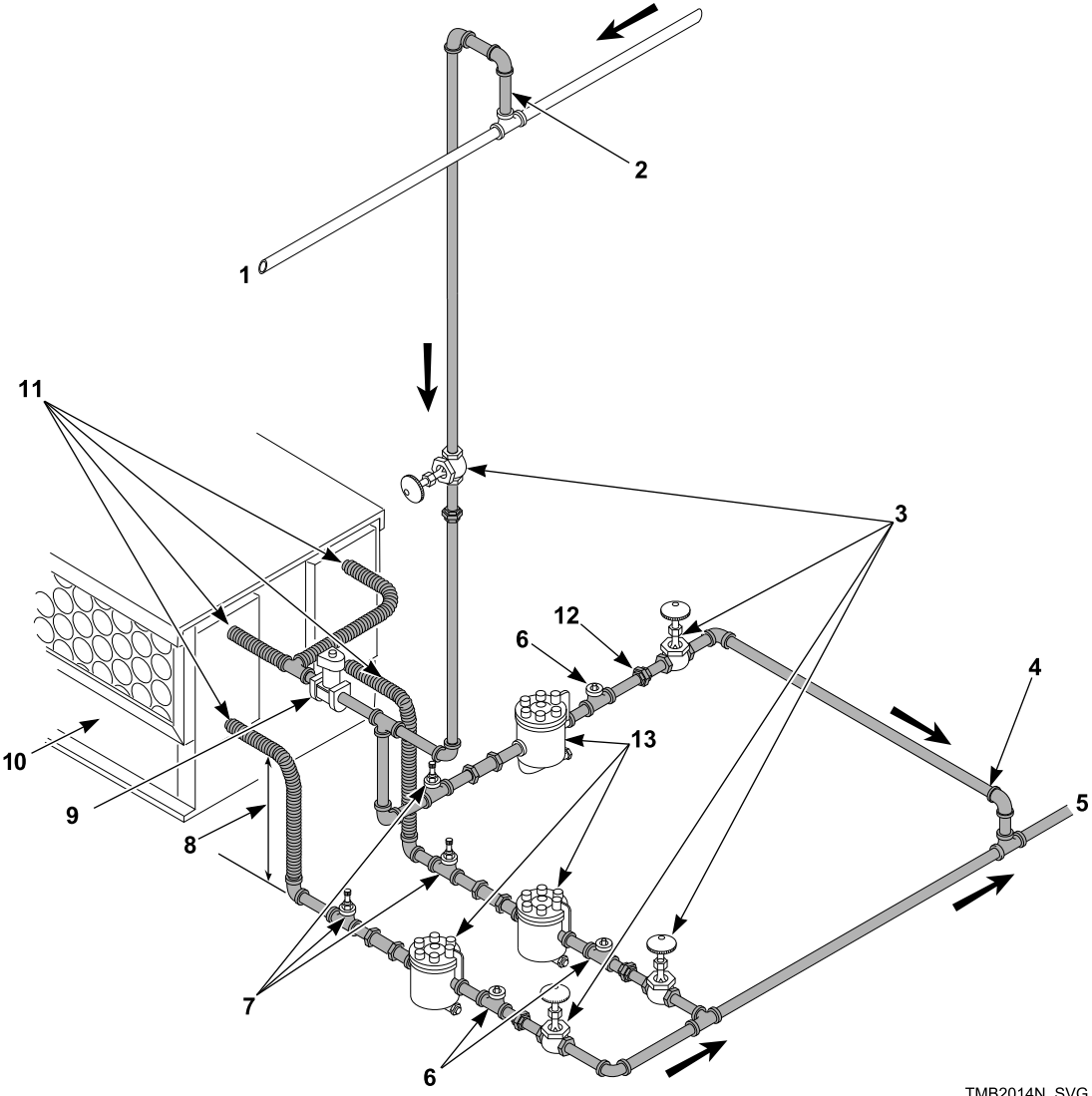

TMB2014N_SVG

NOTE: Refer to Table 11 for sizing of steam lines. Piping must also be sized accordingly for length of runs and number of elbows.

- 1 Supply
- 2 12 in. (305 mm) Riser
- 3 Shut-Off Valve
- 4 Condensate Return Line from Supply Line
- 5 Return
- 6 Check Valve
- 7 Vacuum Breaker (Optional)
- 8 18 in. (457 mm) Drop
- 9 Solenoid Valve (Supplied with machine)
- 10 Steam Bonnet
- 11 Flexible Line
- 12 Union
- 13 Trap with Built-In Strainer

Figure 21 120 Series Tumble Dryers

Steam Requirements

Steam Pressure PSI (bar)	Minimum Supply Pipe Diameter	Steam Trap Size* Pounds Condensate/Hour (Kilograms Condensate/Hour)
80-100 (5.3-6.9)	1 in. NPT	345 (156)
*Based on 6.9 bar.		

Table 11

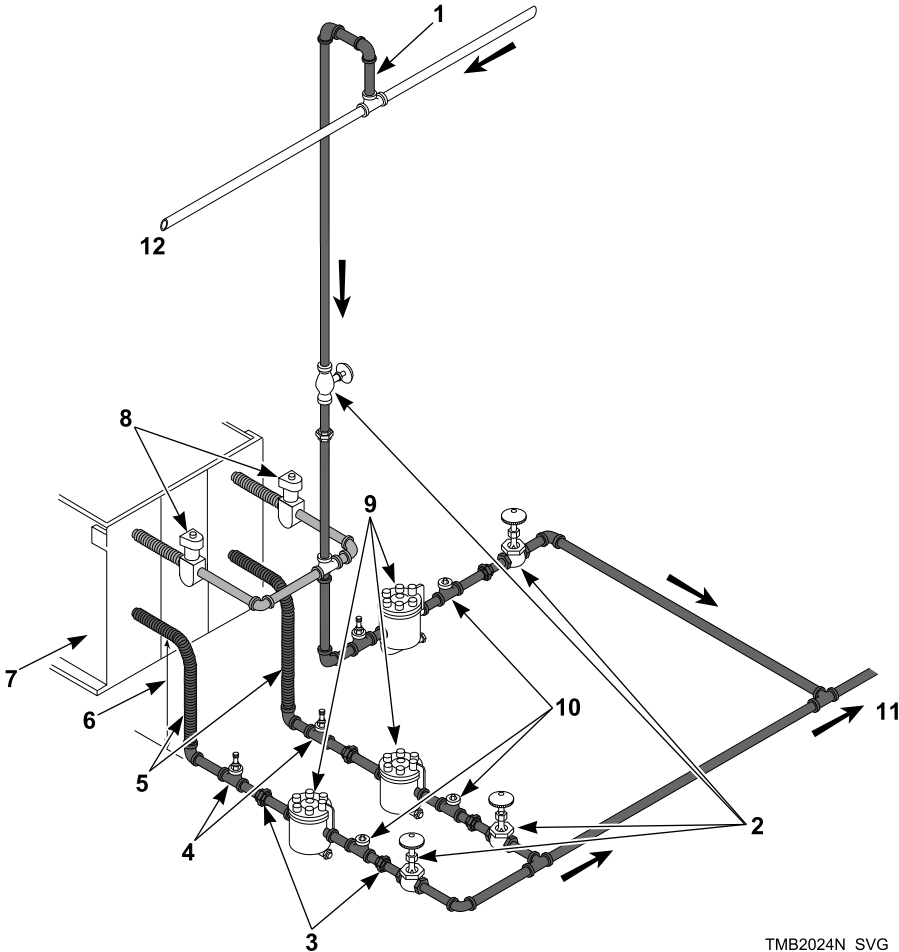

TMB2024N_SVG

NOTE: Refer to Table 12 for sizing of steam lines. Piping must also be sized accordingly for length of runs and number of elbows.

TMB2024N

- 1 Risers 12 in. (305 mm)
- 2 Shut-Off Valve
- 3 Check Valve
- 4 Vacuum Breaker (optional)
- 5 Condensate Return Line from Supply Line
- 6 Drop 18 in. (457 mm)
- 7 Steam Bonnet
- 8 Solenoid Valve (Supplied with machine)
- 9 Union
- 10 Trap with Built-In Strainer
- 11 Return
- 12 Supply

Figure 22 170 and 200 Series Tumble Dryers

Steam Pressure PSI (bar)	Minimum Supply Pipe Diameter	Steam Trap Size* Pounds Condensate/Hour (Kilograms Condensate/Hour)
80-100 (5.3-6.9)	1-1/4 in. NPT	517 (235)
* Based on 6.9 bar.		

Table 12

Piping Recommendations

- Trap each steam coil individually. Always keep the trap clean and in good working condition.
- When tumble dryer is on the end of a line of equipment, extend header at least 4 feet (1.2 m) beyond tumble dryer. Install shut-off valve, union, check valve and bypass trap at end of line. If gravity return to boiler, omit trap.
- Insulate steam supply and return lines for safety of operator and safety while servicing tumble dryer.

IMPORTANT: Steam trap must be installed a minimum of 18 inches (457 mm) below the steam coil outlet connections.

4. Install a shut-off valve to each steam trap.
5. Connect to the condensate return lines.
6. For steam solenoid valve wiring connections, refer to Wiring Diagram supplied with tumble dryer.

Thermal Oil Prep

It is the responsibility of the customer to install appropriate coil and heating system for thermal oil prep models. The manufacturer is not responsible for the performance or safety of the customer installed thermal oil system. To ensure proper operation, refer to the Specifications and Dimensions section for the Btu input of equivalent steam models. Thermal oil systems that do not deliver appropriate Btus will dry slower. For solenoid valve wiring connections, refer to the Wiring Diagram supplied with tumble dryer.

	<h3>WARNING</h3>
<p>All system components must have a 125 psig (8.6 bar) working pressure. Shut-off valves must be installed upstream of the steam solenoid valve and downstream of each steam trap so components can be isolated for maintenance or emergency purposes. All components (solenoid valve, traps) must be supported to minimize loads on the tumbler steam coil connections.</p> <p style="text-align: right;">W701</p>	

Installing Steam Trap and Making Condensate Return Connections

The steam trap must be installed and the coil outlet connections must be connected to the condensate return lines. The following steps outline the procedure for installing the steam trap and connecting the condensate return lines. Refer to *Figure 21 120 Series Tumble Dryers* and *Figure 22 170 and 200 Series Tumble Dryers* for typical installations.

1. Use flexible lines between steam inlet solenoid and steam coils, as well as outlet between steam coil and traps.
2. If necessary, install a strainer at the end of each flexible hose.
3. Install a steam trap to each strainer.

Operating Instructions

Operating Instructions

	WARNING
<p>To reduce the risk of fire:</p> <ul style="list-style-type: none"> • DO NOT DRY articles containing foam rubber or similarly textured rubberlike materials. • DO NOT DRY plastics, anything containing wax or chemicals such as mops and cleaning cloths, or anything dry-cleaned at home with a dry-cleaning solvent. • DO NOT TUMBLE fiberglass curtains and draperies unless the label says it can be done. If they are dried, wipe out the cylinder with a damp cloth to remove particles of fiberglass. 	
W076	

	WARNING
<p>To reduce the risk of serious injury, allow cylinder to stop before cleaning lint screen.</p>	
W412	

Emergency Stop Button On CE Models

All CE approved tumble dryers are factory equipped with an emergency stop button located on the front panel. Refer to *Figure 23*.

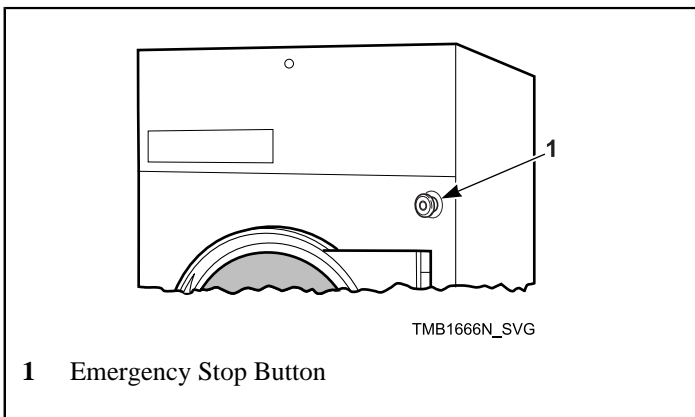

Figure 23

To operate emergency stop button:

- Press red emergency stop button to stop all action.

- To restart machine, pull red emergency stop button out and press START pad or button.

NOTE: Activation of the emergency stop button stops all machine control circuit functions, but DOES NOT remove all electrical power from machine.

Operating Instructions

	WARNING
<p>To reduce the risk of fire, electric shock, or injury to persons, read the IMPORTANT SAFETY INSTRUCTIONS before operating this appliance.</p>	
W727	

IMPORTANT: This appliance shall not be used to dry off solvents or dry cleaning fluids.

1. Clean Lint Screen/Compartment
 - a. Remove any accumulated lint from the lint screen and compartment.
 - b. Close panel tightly against tumble dryer frame and lock panel securely, if applicable.

IMPORTANT: Clean lint screen and lint compartment daily. Failure to clean the lint screen daily will result in higher than normal temperatures that may damage laundry.

	WARNING
<p>To reduce the risk of fire and risk of lint collecting in exhaust duct, do not operate tumbler without lint filter in place.</p>	
W772	

2. Load Laundry
 - a. Open loading door and load cylinder with laundry. Maximum drying load is:

Model	Pound (Kg)
120	120 (54.4)
170	170 (77.1)

Model	Pound (Kg)
200	200 (90.7)

DO NOT OVERLOAD.

NOTE: Overloading causes slow drying and wrinkling.

- b. Close loading door. Tumble dryer will not operate with the door open.
 3. Determine Control Type and Temperature Setting
 - a. Refer to the various controls and follow the instructions for the appropriate control type.
 - b. The type of fabric being dried will determine the temperature setting. Consult the fabric care label or fabric manufacturer to determine proper temperature setting.
- IMPORTANT: Always follow the fabric care instructions supplied by the garment manufacturer.**
4. Remove Laundry
 - a. When the cycle is complete, open door and remove the laundry.

Reversing Operation

Tumble dryers with the reversing option prevent the tangling of large pieces of laundry and minimize wrinkling. These tumble dryers are equipped with a second motor and additional controls which reverse the rotation direction of the cylinder.

Some models may have a switch or touchpad in the control panel area so the operator can select the reversing or nonreversing operation. In nonreversing mode, the cylinder will always turn clockwise (as viewed from the front of the tumble dryer). If the cylinder is turning counterclockwise when switched to nonreversing, it will continue for a few seconds and then start up in the proper direction. Refer to Programming Manual for more information on reversing.

IMPORTANT: After any electrical maintenance is done, make sure that the blower motor is turning counterclockwise as viewed from the front. Then set the reverse control switch to “nonreversing” and note that the cylinder turns constantly clockwise as viewed from the front of the tumble dryer. If not, interchange L1 and L2 service leads to the reverse drive motor.

Control Instructions

Dual Digital Timer Control
RQ Control Suffix

1. Select HIGH, MED, LOW or NO HEAT by turning the temperature knob.

HIGH	Temperature 190°F (88°C)
MED	Temperature 170°F (77°C)
LOW	Temperature 120°F (49°C)

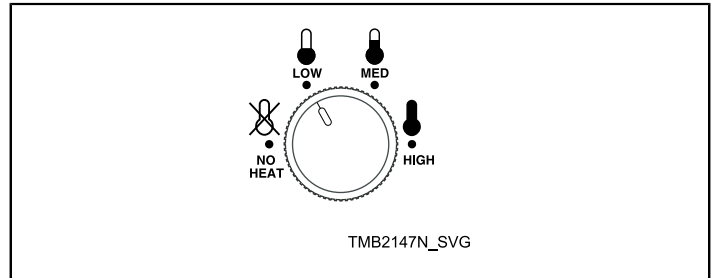

Figure 24

2. Set the HEAT TIME for the number of minutes (from 0 - 60) desired.

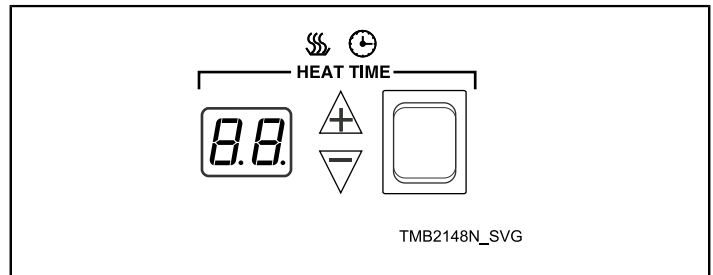

Figure 25

3. Set the COOL DOWN TIME for the number of minutes (from 0 - 15) desired.

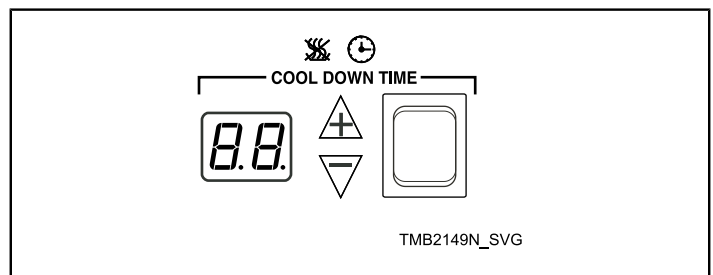

Figure 26

4. Select reversing or nonreversing cylinder rotation setting, if applicable.

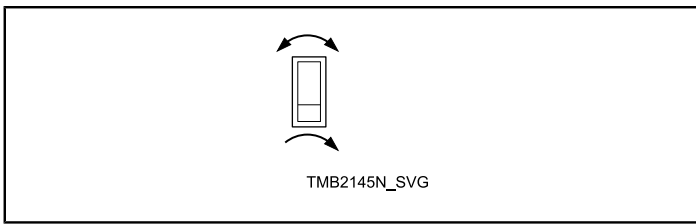

Figure 27

5. Press and release START button to start tumble dryer. Display will show minutes remaining before end of cycle.

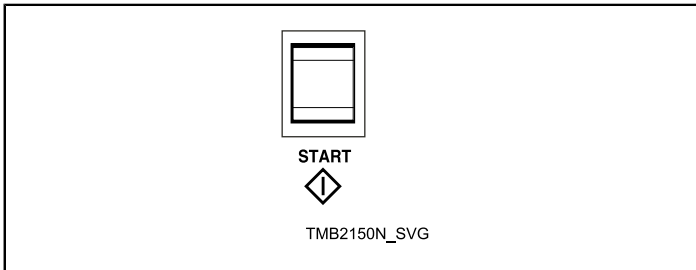

Figure 28

NOTE: One touch drying is available for repetitive loads. If the START button is pressed while the machine is in Idle Mode, when the display is dark, the tumble dryer will repeat the last drying cycle. If the cycle time is adjusted before the cycle is started, the time displayed when the start button was pressed will be used for future cycles.

IMPORTANT: To stop the tumble dryer at any time during the cycle, OPEN DOOR. If the loading door or lint panel door is opened during the cycle, the heating system will shut off and the motor will stop. To restart the cycle, both doors must be closed and the START button must be pressed in.

If the load cools to 90°F (32°C) before cool down time expires, the control will flash “Lr” (load ready) in the heat time display. If the door is not opened, the tumble dryer completes the selected cool down time. If the door is opened after reaching “Lr” temperature, the cycle will be terminated.

NOTE: If display shows an error code, refer to Error Codes section.

6. When the cycle is complete, open door and remove the laundry.

	WARNING
<p>To prevent the risk of fire, remove laundry immediately in case of power failure.</p>	
W779	

NOTE: This machine includes an anti-wrinkle/ extended tumble feature. After the drying cycle is complete, the cylinder will tumble without heat every few minutes. The intermittent tumbling will continue for one hour or until the door is opened. Anti-wrinkle feature will tumble the load without heat for 30 seconds every 2 minutes for 1 hour OR until the loading door is opened.

Display	Definition	Corrective Action
OP	Open thermistor error	<ul style="list-style-type: none"> • Check thermistor. Replace if inoperative. • Check wiring diagram between control and thermistor. Refer to wiring diagram for proper wiring. • Check control. Replace if inoperative.
SH	Shorted thermistor error	<ul style="list-style-type: none"> • Check thermistor. Replace if inoperative. • Check wiring between control and thermistor. Refer to wiring diagram for proper wiring. • Check control. Replace if inoperative.
AF - 1	Airflow switch closed when cycle started	<ul style="list-style-type: none"> • Check airflow switch. Replace if inoperative.
AF - 2	Airflow switch failed to close after cycle started	<ul style="list-style-type: none"> • Check airflow switch. Replace if inoperative.

Display	Definition	Corrective Action
AF (Flashing)	Bouncing Airflow Switch	<ul style="list-style-type: none"> • Check airflow switch to ensure that it is properly aligned and securely mounted in the mounting bracket. • Make sure airflow switch can open and close freely. • Check installation and make sure there is adequate airflow. • Make sure exhaust is not blocked. • Clean the lint screen. • Replace airflow switch if inoperative.
AF (Solid)	Airflow Switch Closed when Resuming Cycle	<ul style="list-style-type: none"> • Allow up to 20 seconds for this condition to clear. • Check if airflow switch opens at end of cycle. • Replace airflow switch if inoperative.

Table 13 Error Codes

Electronic OPL Micro Control

L and P Models with RM Control Suffix

- To use an Automatic Cycle, press an ON/SELECT pad. Select HIGH, MEDIUM, MED LOW, LOW or NO HEAT for items that should not be dried with heat. A light to the left of the selected pad lights up.

HIGH	Temperature 180°F (82°C)
MEDIUM	Temperature 160°F (71°C)
MED LOW	Temperature 140°F (60°C)
LOW	Temperature 120°F (49°C)

To use a Time Dry or Custom Cycle, refer to the Programming Manual.

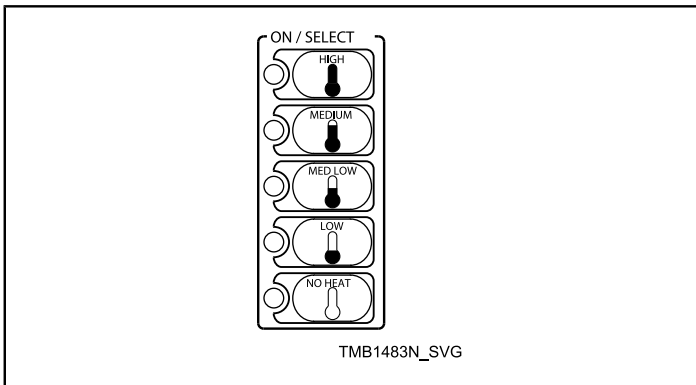

Figure 29

NOTE: Do not press directly on lights or the center of pad. For proper selection, press on pad slightly to the right of center. Refer to Figure 30 .

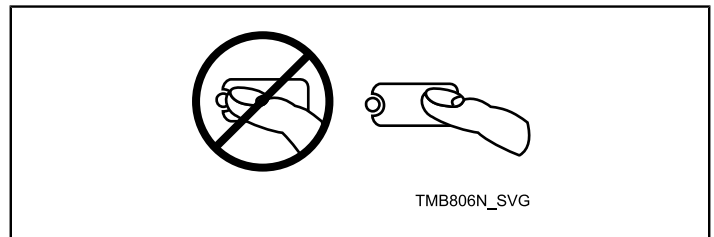

Figure 30

- Select REVERSING or NONREVERSING cylinder rotation setting.

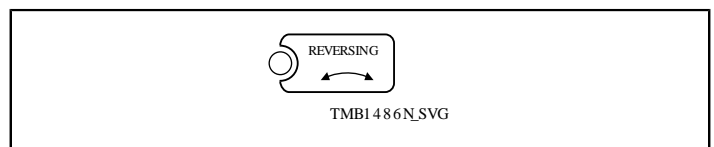

Figure 31

- Press START pad to start tumble dryer.

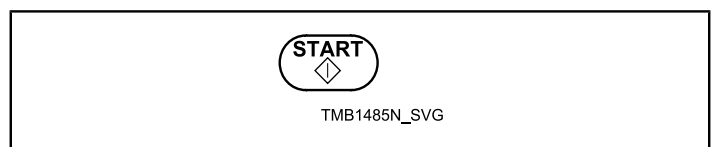

Figure 32

NOTE: All pads can be pressed in any sequence without damaging control or tumble dryer. To stop the tumble dryer at any time, open the door or press STOP/RESET.

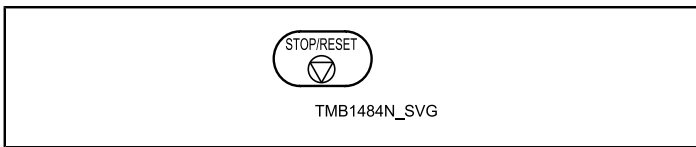

Figure 33

NOTE: The window display will flash. Press **STOP/RESET** twice (within three seconds) to end the cycle and reset the control to idle status. To restart the tumble dryer, **CLOSE** door and press **START** pad.

IMPORTANT: If the loading door or lint panel door is opened during the cycle, the heating system will shut off and the motor will stop. To restart the cycle, both doors must be closed and **START** pad must be pressed.

4. When the cycle is complete, open door and remove the laundry.

	WARNING
To prevent the risk of fire, remove laundry immediately in case of power failure.	
W779	

NOTE: This machine includes an anti-wrinkle/extended tumble feature. After the drying cycle is complete, the cylinder will tumble without heat every few minutes. The intermittent tumbling will continue for one hour or until the door is opened.

G and K Models with RM Control Suffix

1. To use an Automatic Cycle, press a **TEMPERATURE** pad. Select **HIGH**, **MED**, **LOW**, **DELICATE** or **NO HEAT** for items that should not be dried with heat. A light to the left of the selected pad lights up.

HIGH	Temperature 180°F (82°C)
MEDIUM	Temperature 160°F (71°C)
LOW	Temperature 140°F (60°C)
DELICATE	Temperature 120°F (49°C)

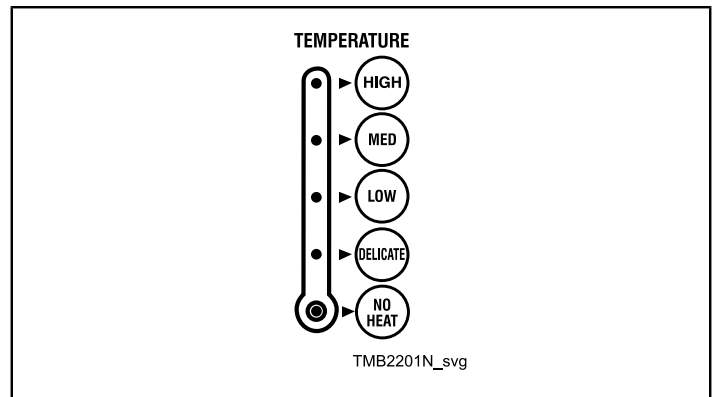

Figure 34

2. To use a Time Dry or Custom Cycle, refer to the Programming Manual.
3. Select **REVERSING** or **NONREVERSING** cylinder rotation setting.

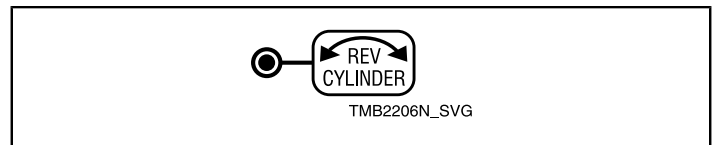

Figure 35

4. Press **START** pad to start tumble dryer.

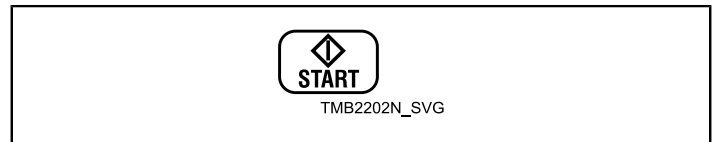

Figure 36

NOTE: All pads can be pressed in any sequence without damaging control or tumble dryer. To stop the tumble dryer at any time, open the door or press **STOP**.

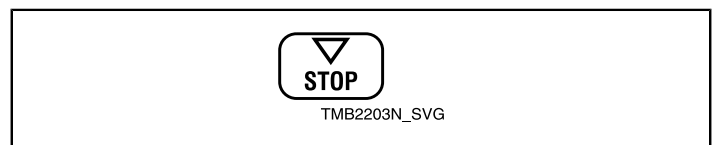



Figure 37

NOTE: The window display will flash. Press **STOP** twice (within three seconds) to end the cycle and reset the control to idle status. To restart the tumble dryer, **CLOSE** door and press **START** pad.



IMPORTANT: If the loading door or lint panel door is opened during the cycle, the heating system will shut off and the motor will stop. To restart the cycle, both doors must be closed and the **PUSH TO START** button must be pressed in.

- When the cycle is complete, open door and remove the laundry.

	WARNING
To prevent the risk of fire, remove laundry immediately in case of power failure.	
W779	

LED OPL Control

RE Control Suffix

- Press the Up or Down keypad to change cycles.
To customize a cycle, refer to the Programming Manual.
- Press START () to start selected cycle.
IMPORTANT: If the loading door or lint panel door is opened during the cycle, the heating system will shut off and the motor will stop. To restart the cycle, both doors must be closed and the START () pad must be pressed.
- When the cycle is complete, open door and remove laundry.

NOTE: This machine includes an anti-wrinkle/ extended tumble feature. After the drying cycle is complete, the cylinder will tumble without heat every few minutes. The intermittent tumbling will continue for one hour or until the door is opened.

	WARNING
To prevent the risk of fire, remove laundry immediately in case of power failure.	
W779	

NOTE: This machine includes an anti-wrinkle/ extended tumble feature. After the drying cycle is complete, the cylinder will tumble without heat every few minutes. The intermittent tumbling will continue for one hour or until the door is opened. After an hour the machine enters delayed tumble and will tumble for two minutes every hour for up to 18 hours or until the door is opened.

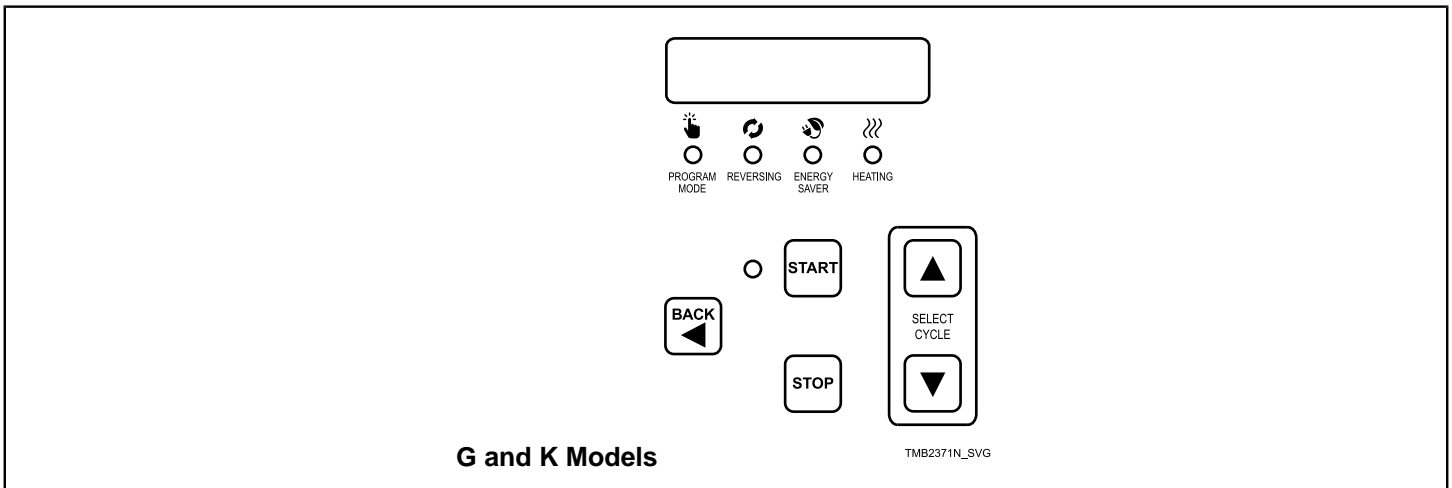

Figure 38

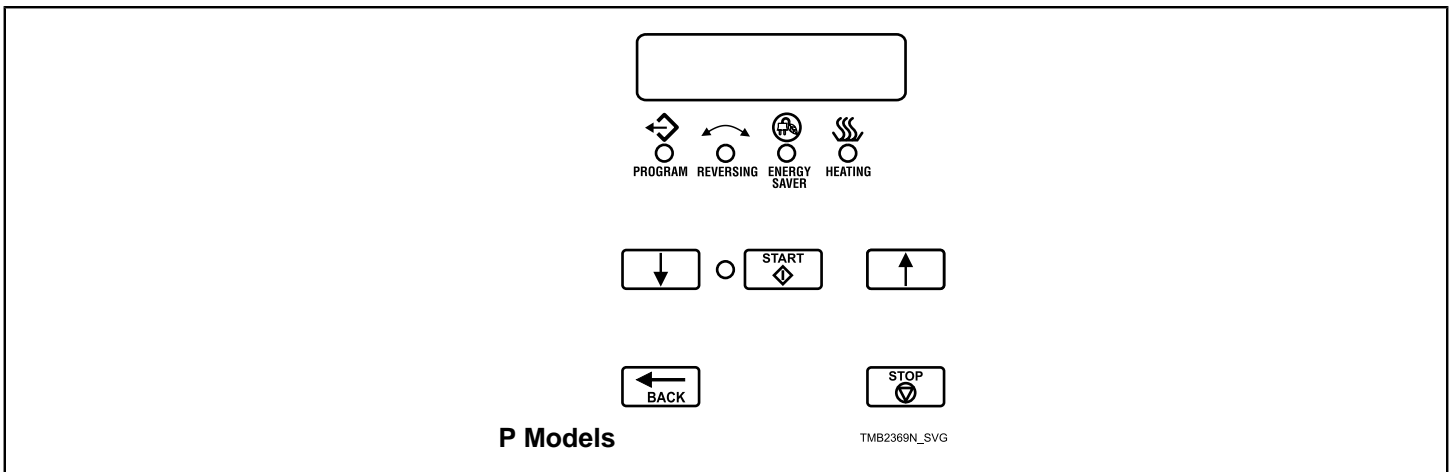

Figure 39

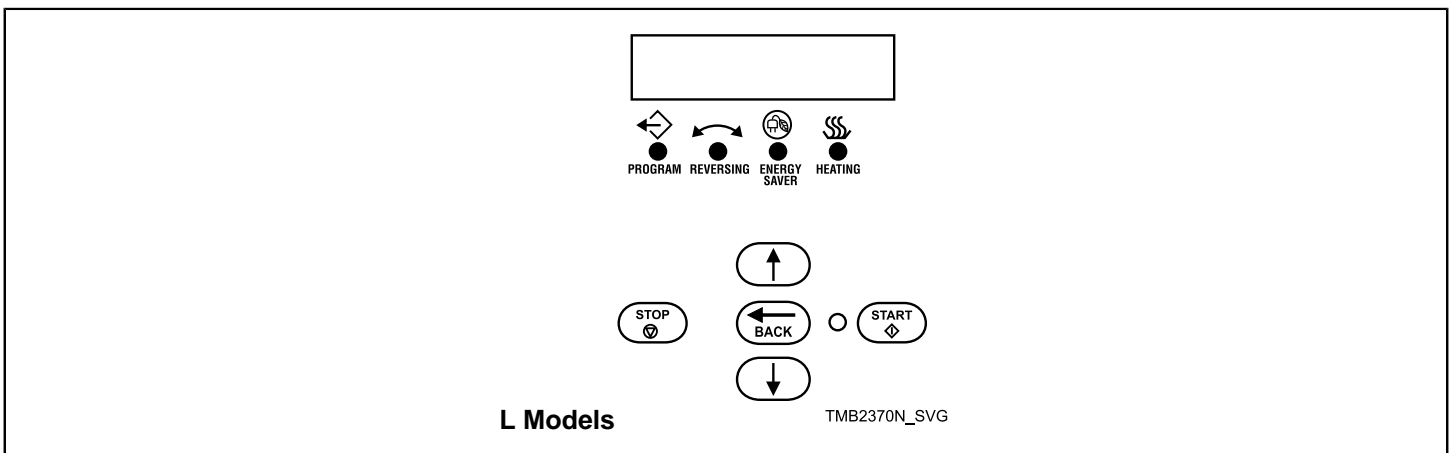

Figure 40

Ignition Control Operation and Troubleshooting for Models Starting 3/11/13

- Verify there is a proper system ground. The igniter, flame sensor and igniter module must share a common ground with the burner. Nuisance shutdowns are often caused by a poor or erratic ground.
- Verify that the system is powered and that the control is calling for heat.
- If the control proceeds to an error code on the red diagnostic LED, troubleshoot per the Fault conditions table below:

WARNING

70458601 and 70458701 controls cannot be serviced by the user. If any control failures are detected, the controls must be replaced by qualified service personnel. Risk of explosion or fire can result if the control module has been opened or with any attempts to repair it and the warranty is void.

W818

Fault Conditions	
LED Indication	Fault Mode
Off	Normal Operation
1 Flash	At Power Up

- Before troubleshooting the system, check the following items:
- Verify all mechanical and electrical connections are secure and tight.
 - Verify all system wiring is correct.

Fault Conditions	
2 Flashes	Flame Without Call For Heat
3 Flashes	Ignition Lockout
4 Flashes (70458701 only)	Manual Reset Error

Fault Conditions	
Steady On	Internal Control Failure

NOTE: The LED will flash on for 1/4 second, then off for 1/4 second during a fault condition. The pause between fault codes is 3 seconds.

Internal Control Failure

If the control detects an error in its software or hardware, all outputs are turned off and the red LED displays a steady ON condition. If this condition persists after an attempt to restart, then the control must be replaced.

Troubleshooting

Troubleshooting Guide	
Symptom	Probable Cause
Control in Lockout Mode (70458701 Control Only)	Manual reset of the control is needed. Reset by pushing red lockout button or use front end control.
Control does not start, green LED is off	<ol style="list-style-type: none"> 24 VAC present between 24V and ground on 70458701 only. If not, see machine schematic. 24 VAC present between TH and ground. If not, see machine schematic.
Thermostat on, no spark or valve	<ol style="list-style-type: none"> Cable connects to control and electrode. Voltage present at gas valve. Bad control. Check red LED for steady on or flashing codes.
Valve on, no spark during TFI	<ol style="list-style-type: none"> Shorted electrode. Spark gap not correct. Set to .094-.156 inch. High voltage cable is faulty or has a poor connection. Control failure.
Spark on, no flame	<ol style="list-style-type: none"> Is gas on? 24 VAC at gas valve. Bad control. Check voltage between gas valve terminal MV and GND on control.

Troubleshooting Guide	
Flame okay during TFI, no flame sense after TFI	<ol style="list-style-type: none"> 1. Check electrode position and cleanliness. 2. Check high voltage wire. 3. Poor ground at burner. 4. Poor flame, check flame current.
Reset failure	<ol style="list-style-type: none"> 1. Reset switch was pressed too long. Try to reset again. 2. Reset switch is shorted. Replace switch.

Proper Electrode Location

Proper location of the electrode assembly is important for optimal system performance. The electrode assembly should be located so that the tips are inside the flame envelope and about 1/2 inch (1.2 cm) above the base of the flame. Refer to *Figure 41*.

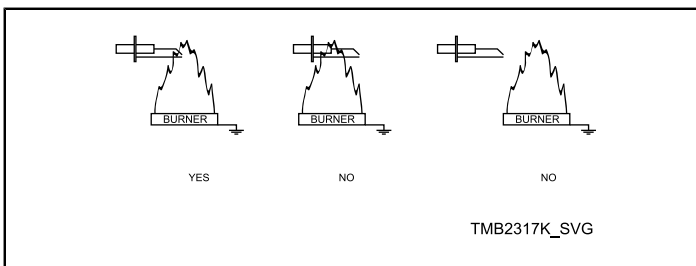

Figure 41

Flame Current Measurement

Flame current is the current that passes through the flame from sensor to ground. To measure flame current, connect a True RMS or analog DC micro-ammeter to the FC+ and the FC- terminals. The reading should be 1.0 micro-amps DC or higher. If the meter reads negative or below “0” on the scale, the meter leads are reversed. Re-connect leads with proper polarity.

Alternately, a Digital Voltmeter may be used to measure the DC voltage between the FC+ and FC- terminals. Each micro-amp of flame current produces 1.0 VDC, so a reading of 2.6 VDC would equate to 2.6 micro-amps.

A good burner ground that matches the control ground is critical for reliable flame sensing.

Ignition Control Operation for Non-CE Models Through 3/10/13

Power Up

When power is applied to the ignition control, the control will begin the ignition sequence within 1 – 3 seconds prepurge waiting time.

Ignition Sequence

The control begins the ignition sequence after prepurge by powering the ignitor and opening the gas valve. The ignitor will remain on either until a flame is sensed or until a maximum of ten (10) seconds (10 +0/-4 sec) has elapsed. If a flame is established and lost during the 10 second period, the ignitor will be powered up again in an attempt to re-ignite the gas.

If no flame is detected within the ten (10) second ignition sequence, the control will terminate power to the gas valves, ignitor, and enter lockout within 5 seconds.

Normal Operation

Once a flame has been established, the spark ignitor will stop sparking and the control will continually monitor all inputs. If the controller senses a loss of flame after flame is established, the gas valve will remain energized and sparking will commence within one second of the flame loss. If flame reattempt fails, lockout will occur within 11 seconds of initial flame loss.

Termination of Flame

Normal flame termination occurs when the thermostat has been satisfied, meaning there is no immediate need for more heat. The thermostat will disconnect power from the ignition control, which will cause the gas valve to close and the flame to go out. After a short period of time, not less than 1 second, the thermostat will cool down and close causing power to be reapplied to the ignition control. When this occurs, the

control must complete the same prepurge and ignition sequence specified above.

Control Lockout

When the control locks out, the gas valve will be closed and all requests for heat will be ignored. The lockout mode may only be discontinued by interrupting power to the control or cycling the thermostat. After this occurs, the control will restart with its normal power up and ignition sequence.

Low Voltage Detection

The control will have capability for detection of a low voltage input condition. If input voltage on power up is below 19.0VAC +0.8VAC/-0.5VAC, the control will disable output to gas valve control relay. If input voltage rises above 19.8VAC for at least three (3) seconds, the control will then re-enable function of the gas valve control relay and ignition sequence may begin. On powerup, the control function must always be disabled if greater than 19.8VAC.

Ignition Control Operation for CE Models Through 3/10/13

Power Up

After 24VAC is applied to the ignition control pins 24V and GND, the Diagnostic LED on the ignition control will turn orange/yellow. If a fault is detected the ignition control will enter Lockout Mode. If no faults are detected, the Diagnostic LED will turn Green and the ignition control will enter Standby Mode.

Standby Mode

While in Standby Mode, the ignition control will continually monitor the system for faults. Once 24VAC is applied to terminals TH and GND on the control, the ignition control will enter Start Up Mode.

Start Up Mode

During Start Up Mode, the ignition control will monitor the system for faults and begin the ignition sequence. If no faults are present, the ignition control will begin the ignition sequence by entering an 18 second waiting period. During this time the Green LED on the ignition control will switch between Red and Green, before maintaining a Green color.

After the waiting period, the ignition control will turn on the igniter and gas valve. The igniter will remain on until a flame is sensed, or up to 10 seconds.

Once a flame has been sensed the ignition control will stop sparking, the gas valve will remain on and ignition control will enter Run Mode.

If a flame is not sensed, the ignition control will then begin two additional retrials for ignition. The ignition control will re-enter the 18 seconds waiting period before the ignition control makes another attempt at ignition. If the three attempts at ignition fail, the ignition control will enter Lockout Mode.

Run Mode

While in Run Mode the ignition control leaves the gas valve on, monitors the flame signal, and leaves the igniter off.

If a flame signal is lost during Run Mode, one additional retrial for ignition will take place within one second. The ignition control will restore the spark for approximately 10 seconds. If the ignition re-attempt fails, the ignition control will enter Lockout Mode.

The ignition control will remain in Run Mode until 24VAC is removed from terminals TH and GND on the control.

Termination of Flame

The flame will go out when power is removed from ignition control. The ignition control will turn off the gas valve and enter Standby Mode.

Lockout Mode

When Lockout Mode is entered, the ignition control will remove power to the gas valve, the igniter will turn off, the Lockout/Reset Light will turn on, and the Diagnostic LED will display the appropriate Error Code.

Lockout Manual Reset

Lockout Mode is cleared by pressing an external reset switch for three seconds. The ignition control will clear all error codes and enter Standby Mode. During Lockout Manual Reset, the Diagnostic LED on the ignition control flashes red and orange, and the Reset Light remains on until the ignition control is reset. After the Reset Light turns off, stop pressing the switch. Holding the reset for three seconds after lockout has been cleared will cause a fault and result in entering Lockout Mode again.

System Tests

The following system tests are performed during normal operation. System tests are performed at a minimum of every 24 hours.

Low Voltage Detection

If the voltage between terminals TH and GND on the control is below 18.75VAC +/- 0.75VAC for more than 3 seconds the

ignition control will turn off the gas valve and will not attempt to spark. The Diagnostic LED will display Error Code 5. The ignition control will not enter Lockout Mode if a low voltage condition is detected, but will enter Standby Mode and wait for the low voltage condition to be cleared.

If the voltage between terminals TH and GND on the control rises above 19.75VAC +/- 0.1VAC for at least 3 seconds, the ignition control will then enter Start Up Mode.

Low Voltage Detection test is disabled during Run Mode.

Gas Valve

The ignition control verifies that the gas valve is connected. Failure of this test results in the ignition control entering Lockout Mode with the Diagnostic LED displaying Error Code 2.

Flame Probe Tests

The Unexpected Presence of Flame test is performed when no flame is expected. Failure of this test results in the ignition control entering Lockout Mode with the Diagnostic LED displaying Error Code 3.

During the Flame Monitoring test, the flame is checked to ensure the gas is being burned when the gas valve is on. Failure of this test will result in the ignition control entering Lockout Mode with the Diagnostic LED displaying Error Code 3.

Diagnostic LED (DGN LED)/Error Codes

The Diagnostic LED or DGN LED is located by the power connector on the ignition control. Refer to *Figure 42* . The Diagnostic LED will indicate the status of the ignition control. Refer to *Table 14* .

LED Color	Description
Orange-Yellow	Initialization
Green	Standby/Normal Operation
Red	Fault Indication Code

Table 14

The Diagnostic LED will flash error codes one half second on and one half second off. Error codes are separated by a one second pause before the code is repeated.

Error Code	DGN LED status	Fault Type
1	Red	Ignition Control Internal Failure
2	2 Red Flashes	Gas Valve Not Connected
3	3 Red Flashes	Ignition/Flame Sense Failure
4	4 Red Flashes	Reset Switch is Shorted
5	Slow Red and Green Flashes	Low Voltage Detection
6	Fast Red and Orange Flashes	Ignition Control is in Reset Delay

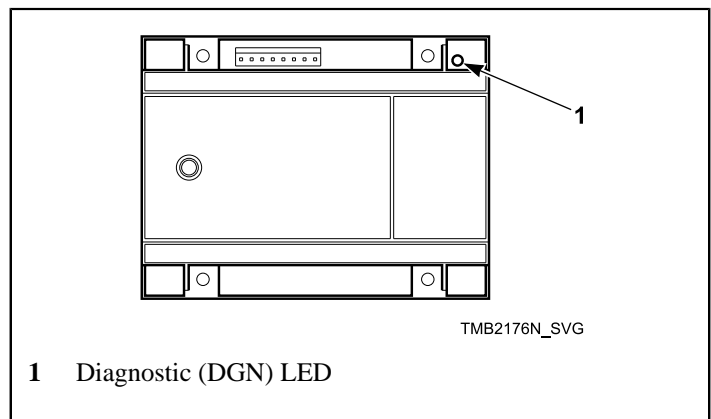



Figure 42

Adjustments

Adjustments

	<h3>WARNING</h3>
<p>To reduce the risk of electric shock, fire, explosion, serious injury or death:</p> <ul style="list-style-type: none"> • Disconnect electric power to the tumble dryer before servicing. • Close gas shut-off valve to gas tumble dryer before servicing. • Close steam valve to steam tumble dryer before servicing. • Never start the tumble dryer with any guards/panels removed. • Whenever ground wires are removed during servicing, these ground wires must be reconnected to ensure that the tumble dryer is properly grounded. 	
<p>W002R1</p>	

Gas Burner Air Shutter

NOTE: Air inlet shutters on the burner must be adjusted so sufficient air is metered into the system for proper combustion and maximum efficiency. Before adjusting the inlet shutters be sure that all lint is removed from lint compartments and lint screen.

Air shutter adjustments will vary from location to location and will depend on the vent system, number of units installed, make-up air and line gas pressure. Opening the shutter increases the amount of primary air supplied to the burner while closing the shutter decreases the primary air supply. Adjust air shutter as follows:

Refer to *Figure 43*.

1. Open the access panel and remove the burner inspection hole plate.
2. Start the tumble dryer and check the flame pattern. If the flame pattern is straight up, insufficient air is flowing through the tumble dryer. A flame pattern that flares to the right and left indicates no air is flowing through the tumble dryer. Correct air and gas mixture is indicated if the flame pattern is primarily blue, with small yellow tips, and bends to the right of the heater section. Too little air is indicated if the flame is yellow, lazy and smokey.
3. To adjust the air shutter, loosen air inlet shutter adjusting screw.
4. Open or close air shutter as necessary to obtain proper flame intensity.

5. After air shutter is adjusted for proper flame, tighten air shutter adjusting screw securely.

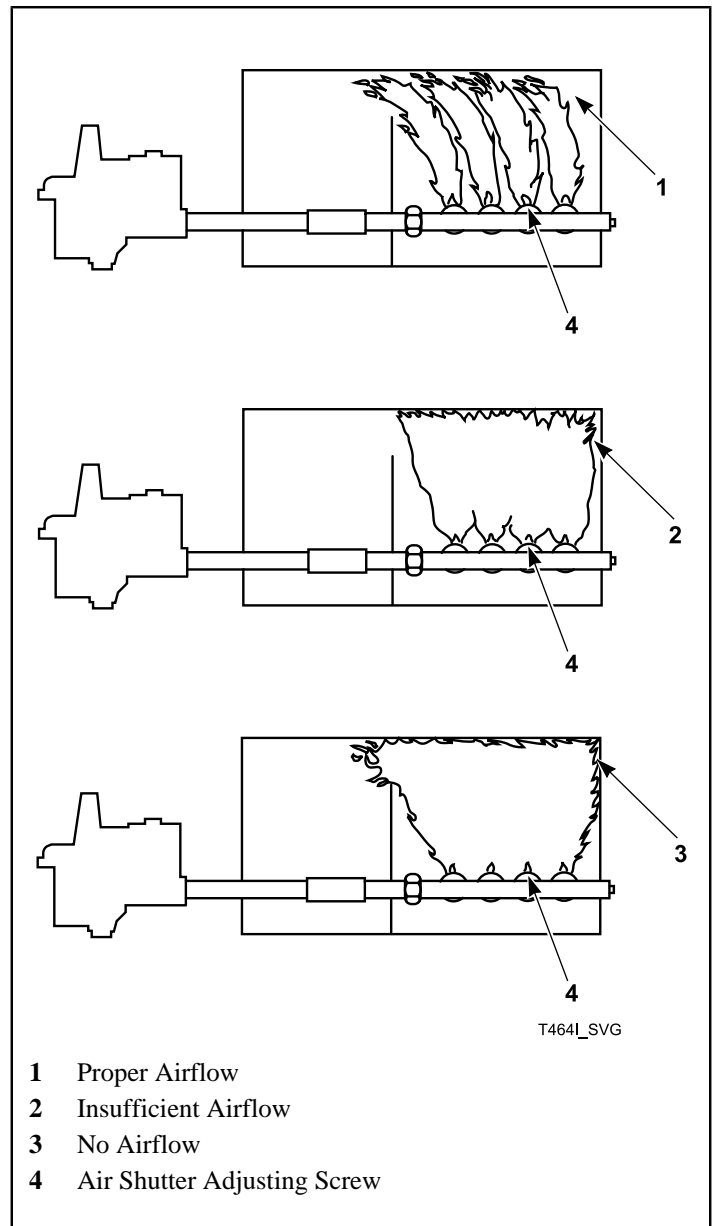



Figure 43

Airflow Switch

The airflow switch is set at the factory for proper operation. No adjustment necessary.

The airflow switch operation may be affected by shipping tape still in place, lack of make-up air, or an obstruction in the exhaust duct. These should be checked and the required corrective action taken.

	WARNING
<p>The tumble dryer must not be operated if the airflow switch does not operate properly. Faulty airflow switch operation may cause an explosive gas mixture to collect in the tumble dryer.</p>	
W072R1	

IMPORTANT: Airflow switch vane must remain closed during operation. If it opens and closes during the drying cycle, this indicates insufficient airflow through the tumble dryer. If switch remains open, or pops open and closed during the cycle, the heating system will shut off. The cylinder and fan will continue to operate even though the airflow switch is indicating insufficient airflow.

NOTE: To properly mount the airflow switch bracket, or in case of a load not drying, the airflow switch bracket may need to be checked for proper alignment. Be sure the locator pins are securely in their respective holes before tightening the bracket mounting screws. This will assure proper alignment of the airflow switch arm in the channel of the airflow switch bracket and prevent binding of the arm.

Loading Door Switch

Loading door switch is factory preset, no field adjustment is necessary.

Loading Door Catch (120 and 170 Series Models)

The door catch must be adjusted to have sufficient tension to hold loading door closed against force of load tumbling against it. Proper adjustment is when 7-15 pounds (0.48-1.03 bar) pull is required to open door.

If adjustment is required, refer to *Figure 44* and proceed as follows:

1. Open door.
2. Loosen acorn nut.
3. Turn door strike screw in or out as required.
4. Tighten acorn nut.

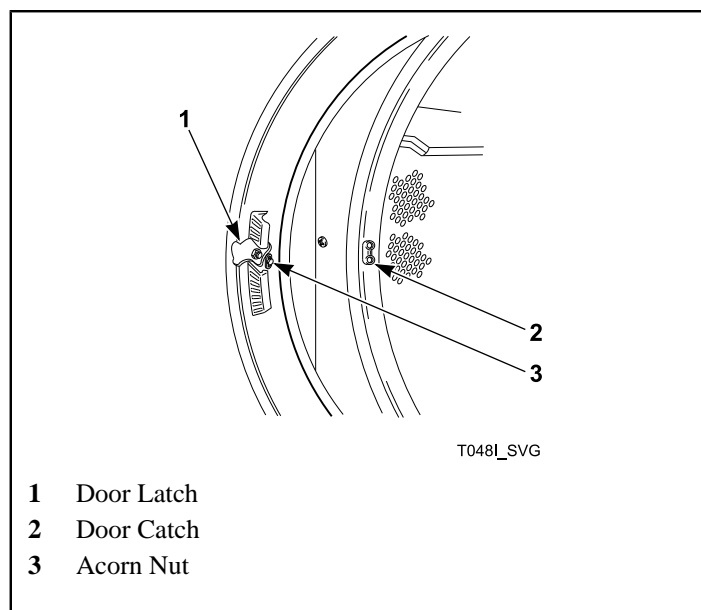

Figure 44

Loading Door Strike (200 Series Models)

The loading door strike must be adjusted to have sufficient tension to hold loading door closed against force of load tumbling against it. Proper adjustment is when 8-15 pounds (35.6-66.7 N) pull is required to open door. If adjustment is required, refer to *Figure 45* and proceed as follows:

1. Open door.
2. Loosen adjustment screws.
3. Position strike for desired magnet engagement.
4. Retighten screws.

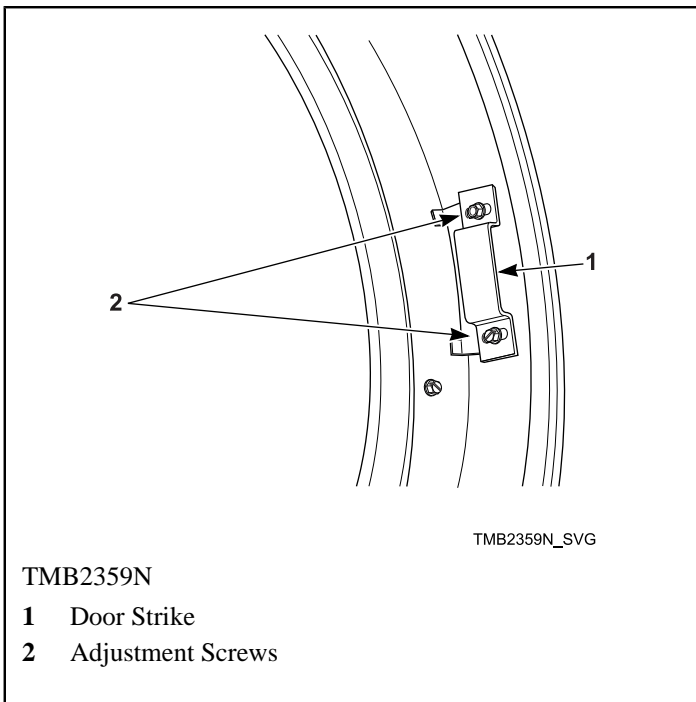

Figure 45

Belt Drive

The drive assemblies consist of motors, belts, eyebolts and a step pulley.

The pulley diameters are sized to produce a cylinder speed of 37-39 RPM for 120 series models or 29-31 RPM for 170 and 200 series models.

The step pulley assembly is used for speed reduction as well as a means of adjusting belt tension. The pulley mounting plate is attached to the cabinet. The frame mounting plate has vertically slotted holes allowing up and down movement of the step pulley mounting plate for belt adjustment.

Adjust the belt tension as follows:

1. Disconnect electrical power to the tumble dryer before attempting any adjustments to the drive assembly.
2. Loosen pulley mounting plate bolts.
3. Loosen the upper nut on the final drive eyebolt.
4. Rotate the lower nut of the final drive eyebolt clockwise until proper belt tension is achieved.
5. Rotate upper nut clockwise against the lower nut in order to lock it into place.
6. Tighten pulley mounting plate bolts. Recheck belt tension.
7. If necessary, adjust the drive motor belt tension eyebolt using a similar procedure.
8. Adjust blower belt tension on 120 series 50 Hertz tumble dryers and all 170 series tumble dryers using a similar procedure.

NOTE: Proper tensions for new belts are measured with a Belt Tension Gauge:

	Drive Motor		Final Drive		Blower	
	Initial	After Run-in	Initial	After Run-in	Initial	After Run-in
120	60-70	45-55	70-80	55-65	60-70	50-55
170	60-70	45-55	70-80	55-65	75-80	60-65
200	60-70	45-55	70-80	55-65	65-70	55-60

Table 15

NOTE: Using a Belt Tension Gauge, the motor belt deflection should be 0.31 inch at five pounds pressure, and final drive belt deflection should be 0.25 inch at five pounds pressure.

Belts should not slip or make any noise when starting up under normal load.

Maintenance

Daily

1. Inspect the area surrounding tumble dryers, remove all combustible materials, including lint, before operating the machines.
2. Check cylinder for foreign objects to avoid damage to clothing and equipment.
3. Clean lint from lint compartment and screen to maintain proper airflow and avoid overheating.

	WARNING
<p>To reduce the risk of serious injury, do not open the lint panel while the tumble dryer is in operation. Before cleaning the lint screen, open tumble dryer door and allow cylinder to completely stop.</p>	
W410R1	

- a. Open the lint panel.
 - b. Remove all accumulated lint in the lint compartment area. Lightly brush any lint that may be left on the lint screen.
 - c. Be sure the lint screen is not torn.
 - d. The lint screen is designed to completely cover the entire opening in the lint screen panel. Be sure that it does so.
 - e. Wipe lint off of the cabinet high limit thermostat and thermistor. Refer to *Figure 46* .
 - f. Replace the lint compartment panel on the tumble dryer ensuring a tight fit, and lock if applicable.
4. At end of day, clean the machine's top, front and side panels with mild detergent. Rinse with clean water. DO NOT use products that contain alcohol on the control panel.

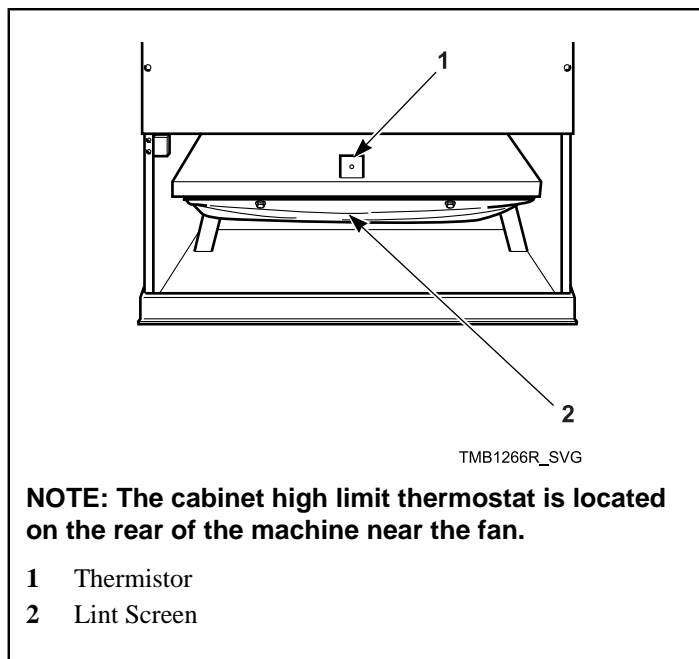

Figure 46

Monthly

1. Remove lint and debris from inside exhaust duct to maintain proper airflow and avoid overheating.
 - a. Remove external duct and duct access covers, if present.
 - b. Clean inside of duct with a vacuum.
 - c. Clean dampers and make sure they operate freely.
2. Ensure even lint distribution over lint screen.
3. Carefully wipe any accumulated lint off the cabinet high limit thermostat and thermistor, including perforated cover.
4. Clean lint and debris buildup from blower to maintain proper airflow.

Quarterly

1. Use a vacuum to clean air vents on drive motors.
2. Use a vacuum to clean lint from rear limit thermostat cover.
3. Check and clean steam coils, if applicable.
4. Check flow of combustion and ventilation air.
5. Check belt tension and condition. Replace worn or cracked belts.

Bi-Annually

1. Check mounting hardware for any loose nuts, bolts or screws.
2. Check gas connections for leakage.
3. Check for loose electrical connections.

4. Check steam connections for looseness and leakage.
5. Remove all front panels and vacuum, including coin drop mechanisms.
6. Check cylinder and front panel seals.
7. Inspect cabinet and inner panels for any damage, replace or repair as needed.
8. Clean burner tubes and orifice area of any lint buildup.

Annually

1. Remove burner tubes.
2. Clean using water and a brush.

Fire Suppression System (Optional Equipment) Maintenance Test

NOTE: Fire suppression system only available on gas and steam models.

To ensure proper operation, the fire suppression system must be tested every three months. If the system test does not perform as indicated:

1. Discontinue use of the tumble dryer.
2. Refer to Troubleshooting Manual or contact a qualified service person.
3. Restore the fire suppression system to proper working order before using tumble dryer.

Create a maintenance record with a check box for pass, the date and a signature. Store this record in an area where it will not be damaged, but is easily accessible to person performing tests.

NOTE: Failure to maintain the fire suppression system will void the tumble dryer warranty.

NOTE: The auxiliary output is activated during the fire suppression system maintenance test sequence. Consider this fact prior to testing the system every three months. (Example – If the external system uses the auxiliary output to call the fire department, inform the fire department before and after the fire suppression system maintenance test.)

	CAUTION
Clean up any water spilled during testing to avoid personal injury.	
W487	

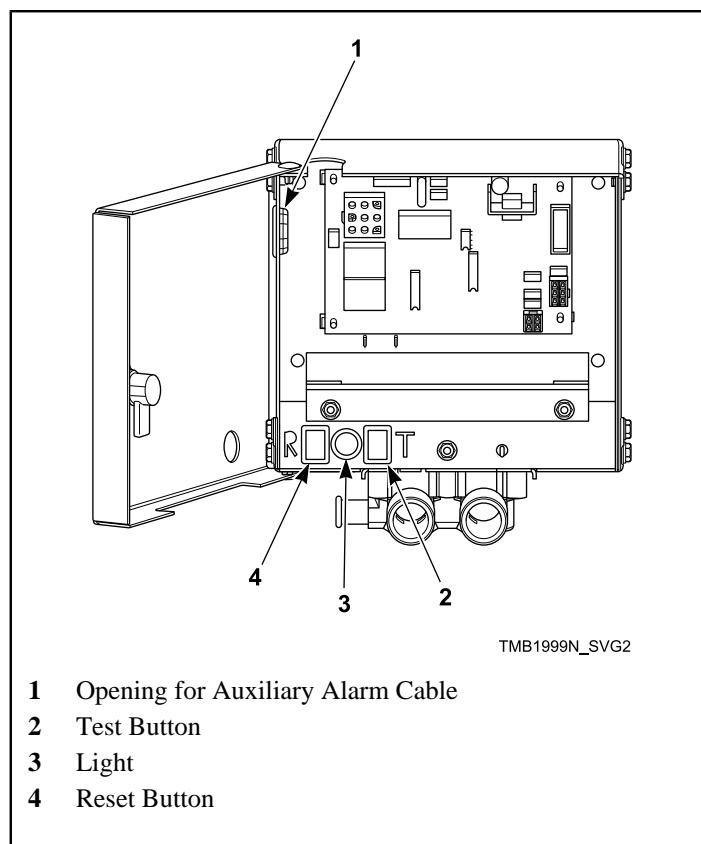

Figure 47

To perform the fire suppression system maintenance test:

1. If the auxiliary alarm output is connected to a separate alarm system, disconnect prior to performing the fire suppression system maintenance test.
2. Remove any lint from the lint compartment.
3. Ensure temperature sensors are free of lint.
4. Place a load of dry towels in the tumble dryer. Refer to *Table 16* for proper load size. Ensure the cylinder baffles are to the left and right of the spray manifold located at the center top of the cylinder.
5. Unlock the fire suppression system control box.
6. Press and hold the test button, verify the light is on, this should take approximately five seconds. Refer to *Figure 47*. After a one-second pause water should begin to spray into the cylinder.
7. After 15 seconds of water spray, press and hold the reset button until water spray is off and light is off. This should take approximately one second. Refer to *Figure 47* and *Figure 48*.
8. Immediately remove and weigh the load. Refer to *Table 16* for acceptable weight range. If less than minimum pounds indicated in *Table 16*, the fire suppression system has failed the maintenance test. Refer to the Troubleshooting Manual.

IMPORTANT: If the fire suppression system failed the maintenance test, DO NOT operate the tumble dryer.

	Dry Weight	Wet Weight	Minimum Weight
	lbs. (kg)	lbs. (kg)	lbs. (kg)
120	60 (27)	75-79 (34-36)	70 (32)
170	80 (36)	95-99 (43-45)	90 (41)
200	100 (45)	115-119 (52-54)	110 (50)

Table 16

9. Clean up any water on the floor.
10. Lock the fire suppression system control box.
11. If the separate alarm option is being used, reconnect the auxiliary alarm output.
12. Start the tumble dryer to dry the test load.
13. On maintenance record, check box if fire suppression system passed the test, date and sign record.

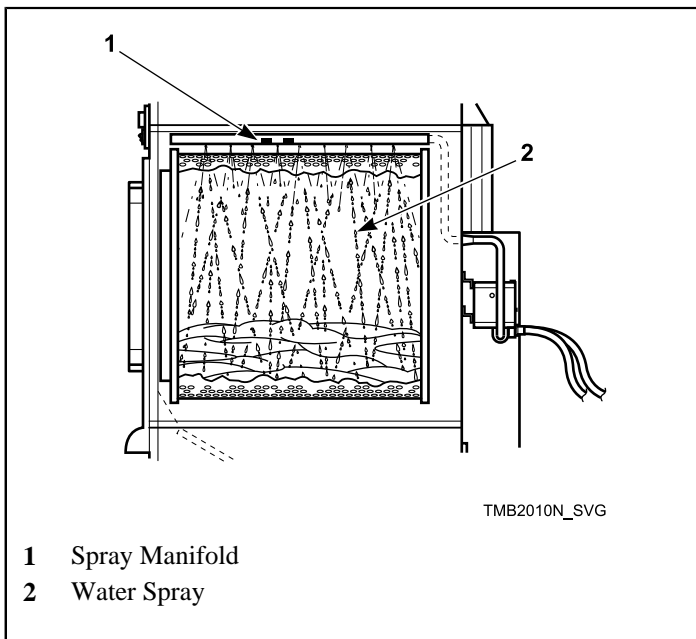

Figure 48

Before You Call for Service

Won't Start	Won't Heat	Clothes Not Dry	Possible Reason – Corrective Actions
•			Insert correct coin(s) or valid card if applicable.
•			Close the loading door tightly.
•			Close lint panel tightly.
•			Press the PUSH-TO-START or START pad/button.
•			Be sure power cord is plugged all the way into the electrical outlet.
•			Drying timer is in OFF position.
•			Check the main fuse and circuit breaker.
•			Check fuses located in the machine.
	•		Insufficient airflow.
	•		Gas shut-off valve in OFF position.
	•		Are controls properly set?
	•		Broken drive belt. Call the service person.
	•	•	Tumble dryer is in Cool Down Mode.
	•	•	Lint screen clogged. Clean lint screen.
	•	•	Exhaust duct to outside is blocked. Clean out.

Removing Tumble Dryer from Service

If the tumble dryer is to be removed from service, perform the following steps where applicable:

1. Turn off electrical supply external to machine.
2. Turn off electrical disconnect on machine.
3. Turn off gas supply external to machine.
4. Turn off manual gas shut-off valve on machine.
5. Turn off steam supply external to machine.
6. Remove all electric, gas and steam connections.

Disposal of Unit

This appliance is marked according to the European directive 2002/96/EC on Waste Electrical and Electronic Equipment (WEEE).

This symbol on the product or on its packaging indicates that this product shall not be treated as household waste. Refer to *Figure 49*. Instead it shall be handed over to the applicable collection point for the recycling of electrical and electronic

equipment. Ensuring this product is disposed of correctly will help prevent potential negative consequences for the environment and human health which could otherwise be caused by inappropriate waste handling of this product. The recycling of materials will help to conserve natural resources. For more detailed information about recycling of this product, please contact the local city office, household waste disposal service, or the source from which the product was purchased.

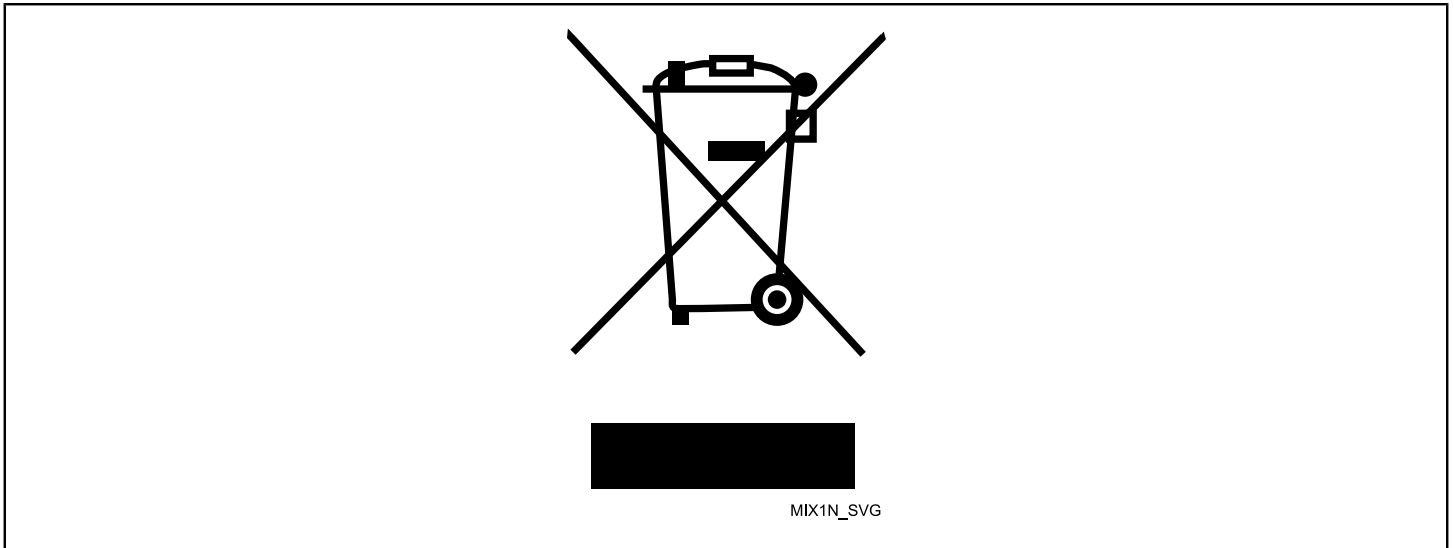

Figure 49